

DENON

Hi-Fi Pre-Main Amplifier

SERVICE MANUAL MODEL PMA-790

SOLID-STATE PRE MAIN AMPLIFIER

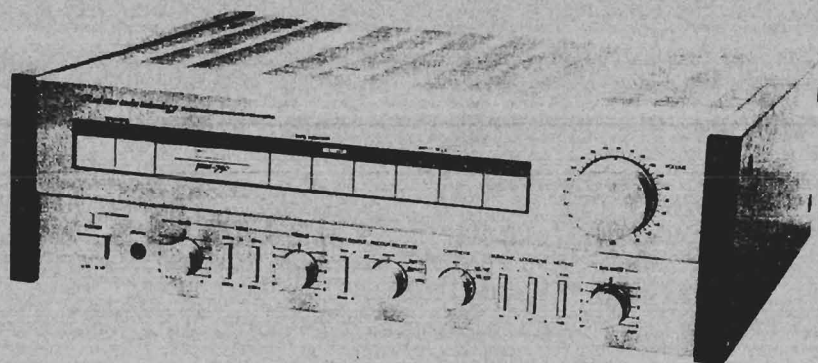

TABLE OF CONTENTS

SPECIFICATIONS	1
DESIGNATIONS AND FUNCTIONS OF FRONT PANEL CONTROLS	2
CONNECTIONS	3
BLOCK, LEVER DIAGRAM	4
METHOD OF ADJUSTMENTS	5 ~ 6
SEMICONDUCTORS	7
PRINTED WIRING BOARD PATTERNS AND PARTS LIST	
INPUT & EQ. UNIT ETC0556B	8
POWER AMP. & POWER SOURCE UNIT PUS0021B	9 ~ 10
CONTROL & LAMP UNIT ETC0057B	11 ~ 12
POWER SUPPLY & PROTECTOR UNIT ETC0558B	13 ~ 14
CONNECTION DIAGRAM	15
WIRING DIAGRAM	16
EXPLODED VIEW OF CHASSIS AND CABINET	17

NIPPON COLUMBIA CO., LTD.

SPECIFICATIONS

POWER AMPLIFIER SECTION

Rated Output Power: Both channel drive
 20 Hz to 20 kHz (8 ohm Load THD 0.002% -3 dB)
 150 W + 150 W (DIN, U.K., EUROPE, U.S.A.)
 20 Hz to 20 kHz (4 ohm Load) 240 W + 240 W (U.K., U.S.A.)
 1 kHz (8 ohm Load) 150 W + 150 W (IEC)
 (Subject to change by temperature test)

Total Harmonic Distortion: 0.002% (20 Hz - 20 kHz at -3 dB rated output 8 ohm Load)
 0.01% (20 Hz - 20 kHz at rated output 8 ohm Load) (U.S.A.)

Intermodulation Distortion: Below 7 kHz / 60 Hz : 1/4 0.0015% (at amplitude output equivalent to rated output)

Output Band Width: 5 Hz - 80 kHz (IHF THD 0.015%) 8 ohm Load

Transmission Characteristics: 1 Hz - 300 kHz $\begin{matrix} +0 \text{ dB} \\ -3 \text{ dB} \end{matrix}$ (at 1 W output)

Input Sensitivity: 150 mV

Input Impedance: 47 k ohm

Output Impedance: 0.1 ohm (1 kHz)

Output Terminals: Speaker: A and B Load 8 - 16 ohm
 A + B Load 8 - 16 ohm
 Headphone/Stereo headphone

EQUALIZER AMPLIFIER SECTION

Equalizer Amplifier Output: Maximum Output: 12 V (at 47 k ohm Load)
 Rated Output: 150 mV
 Total harmonic wave distortion: below 0.001%
 (at 1 kHz, 10 V output)

Input Sensitivity/Input Impedance: PHONO-1, 2 MM 2.5 mV 47 k ohm
 MC High 250 μ V, Low 125 μ V 100 ohm
 TUNER 150 mV 47 k ohm
 DAD/AUX, TAPE 150 mV 47 k ohm

RIAA Deviation: PHONO-1, MM, MC within ± 0.2 dB (20 Hz - 100 kHz)

OVERALL CHARACTERISTICS

SN Ratio (IHFA Network): PHONO-1, 2 MM 90 dB (input terminals short-circuited for 2.5 mV input)
 MC 75 dB (input terminals short-circuited for 250 μ V input)
 TUNER, TAPE, DAD/AUX: 110 dB (input terminals short-circuited)

Tone Control Adjustable Range: BASS 100 Hz ± 8 dB/50 Hz ± 8 dB
 TREBLE 10 kHz ± 8 dB/20 kHz ± 8 dB

Filter Characteristics: SUBSONIC 18 Hz, 6 dB/oct.

Loudness Characteristics: Low frequency 100 Hz + 7 dB
 High frequency 10 kHz + 6 dB

Muting -20 dB

AC OUTLET: SWITCHED x 2, 100 W (Total)
 (For U.S.A. and Canada) UNSWITCHED x 1, 250 W

POWER SOURCE: Germany and France AC 220 V, 50 Hz; U.K. AC 240 V, 50 Hz;
 U.S.A. AC 120 V, 60 Hz; 110 V / 120 V / 220 V / 240 V, 50 Hz (Multiple)

POWER CONSUMPTION: 300 W (IEC); 380 W (Multiple)

DIMENSIONS: 506 mm (W) x 168 mm (H) x 451 mm (D)
 508 mm (W) x 168 mm (H) x 451 mm (D)
 (including rubber feet, control knobs, and terminals)

WEIGHT: 20 kg

Design and specifications are subject to change without prior notice.

NOTE: The following codes correspond to the appropriate models.
 E2 for Europe, EG for Germany, EK for U.K., E3 for U.S.A., E1 for Hong Kong, Singapore.
 This Service Manual is prepared based on E2.

DESIGNATIONS AND FUNCTIONS OF FRONT PANEL CONTROLS

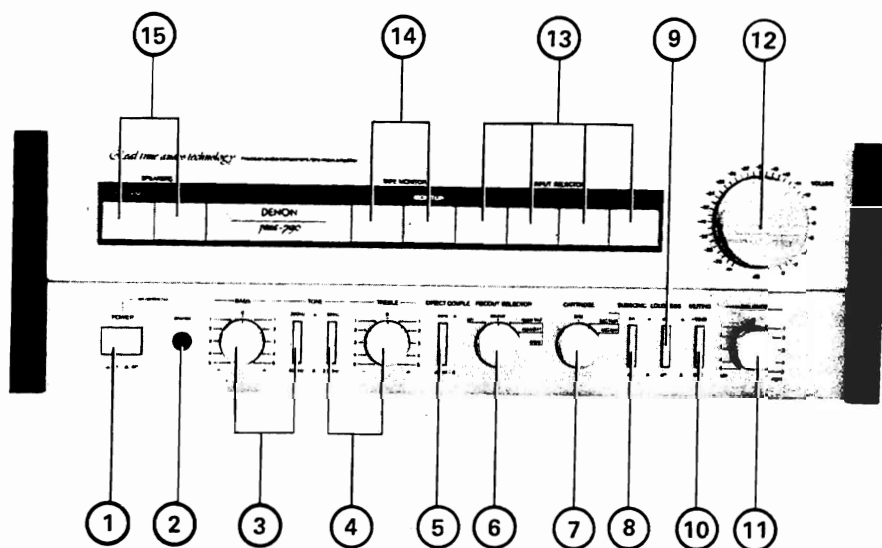

Fig. 1

- ① POWER & on/Protection LED indicator on, off
- ② PHONES (Head Phones Jack)
- ③ BASS (Bass Control Knob) 200 Hz, 400 Hz
- ④ TREBLE (Treble Control Knob) 5 kHz, 2.5 kHz
- ⑤ DIRECT COUPLE (Direct Couple Switch) tone direct
- ⑥ REC OUT SELECTOR (Rec Out Selector Switch)
off, source. tape 1 ► 2, tape 2 ► 1
- ⑦ CARTRIDGE (Cartridge Changeover Switch)
MM, MC High, MC Low
- ⑧ SUBSONIC (Subsonic Filter Switch) on, off
- ⑨ LOUDNESS (Loudness Control Switch) on, off
- ⑩ MUTING (Muting Switch) 0 dB, -20 dB
- ⑪ BALANCE (Balance Control Knob)
left, 5, 4, 3, 2, 1, 0, 1, 2, 3, 4, 5, right
- ⑫ VOLUME (Volume Control Knob)
 ∞ , -70, -58, -50, -43, -37, -34, -30, -26, -22,
-20, -18, -16, -14, -12, -10, -8, -6, -4, -2, 0 dB
- ⑬ INPUT SELECTOR (Input Changeover Switch)
PHONO-1, PHONO-2 TUNER, DAD/AUX.
- ⑭ TAPE MONITOR (Tape Monitor Switch)
1-TAPE-2, MONITOR
- ⑮ SPEAKERS (Speaker Changeover Switch)
SYSTEM A, SYSTEM B

CONNECTIONS

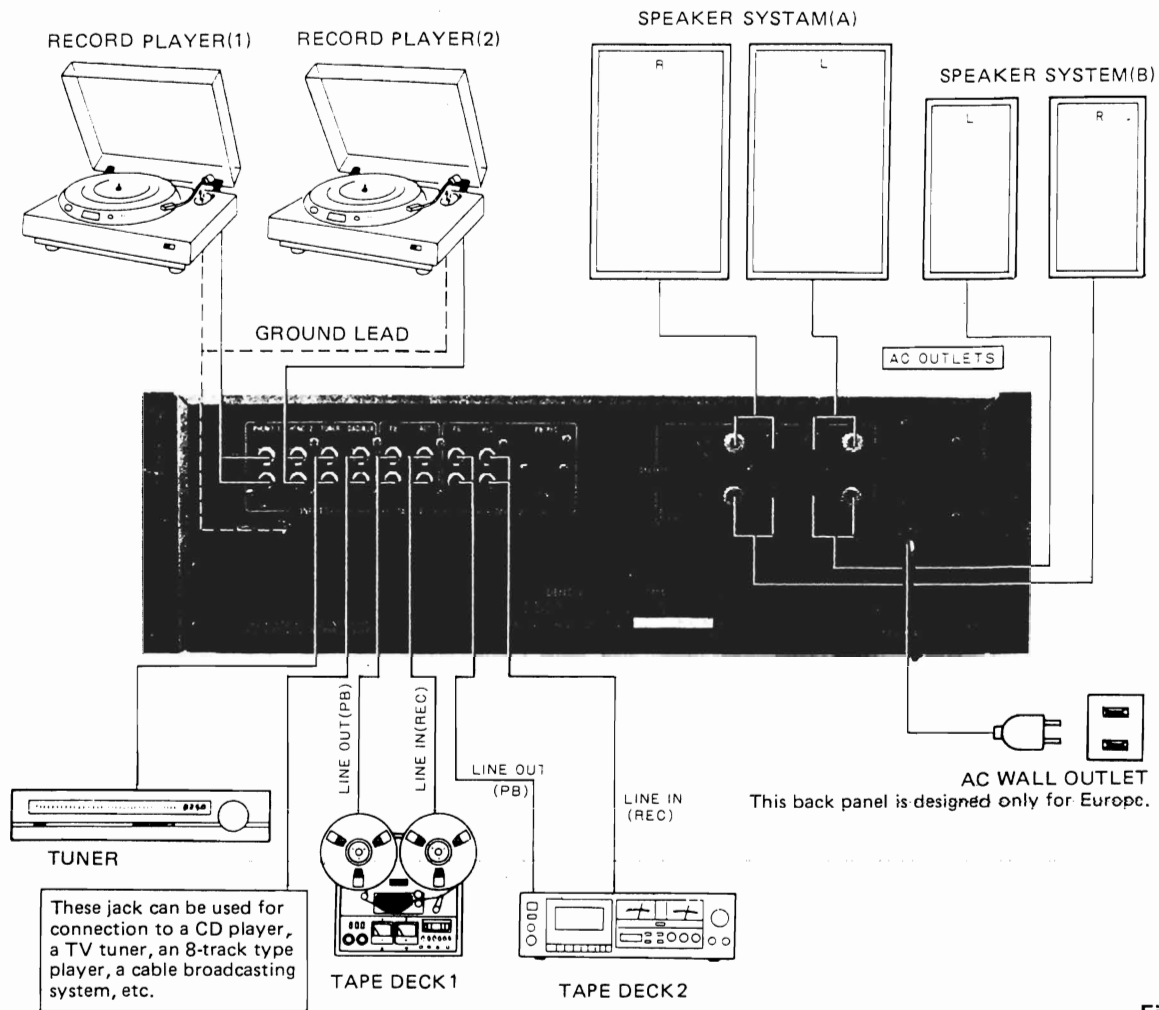

Fig. 2

• Make Connections with Caution

- Do not connect Power cord to AC outlet until all connections completed.
- Distinguish Left and Right. Be sure connect L to L, and R to R.
- Insert the Plugs snugly. Improper connections may invite noise.
- AC outlets of the unit accept Audio equipment only: do not connect hair dryer etc. to the outlets.
- Do not tie Pin plug with Power cord or lay it along power transformer: it may invite hum and noise.
- "PHONO" input terminal is very highly sensitive. Be sure connect Pin cord to it or may induce hum from the Speakers.

For USA, CANADA and HONG KONG MODEL only

AC OUTLET

AC OUTLETs of the Unit accept Tuner, Record Player, Tape Deck etc. which are used with the unit.

SWITCHED (100W max):

Power is turned on-off by the Power Switch.

UNSWITCHED (250W max):

Always alive independent of Power Switch.

BLOCK, LEVEL DIAGRAM

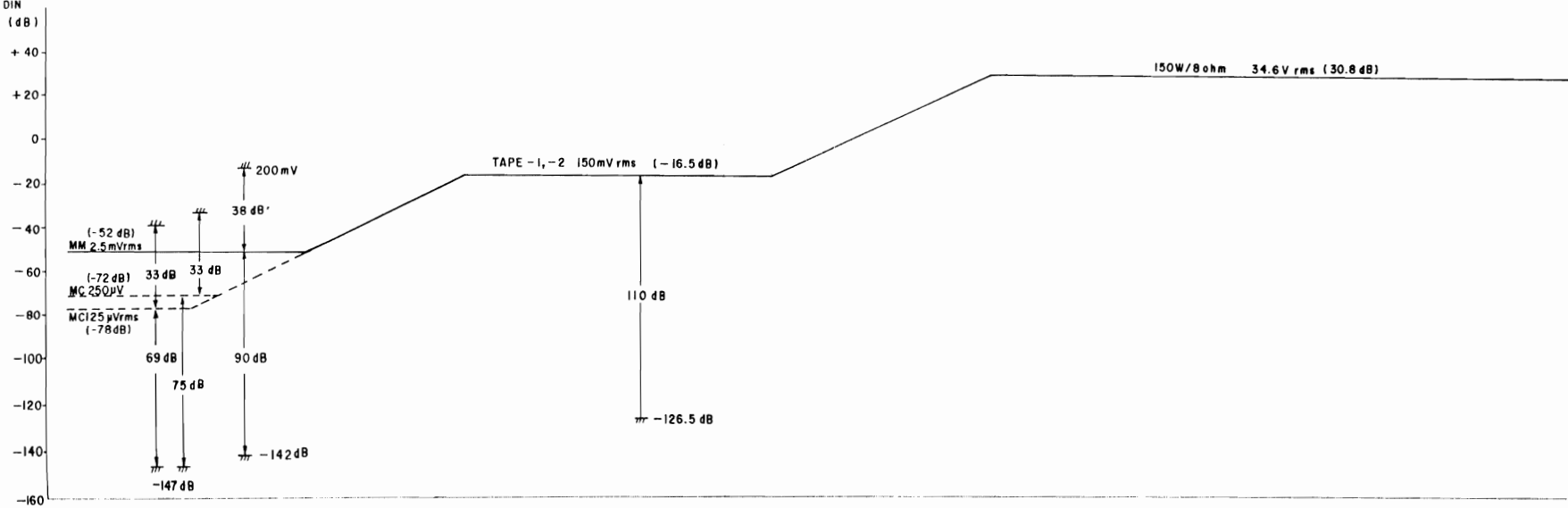
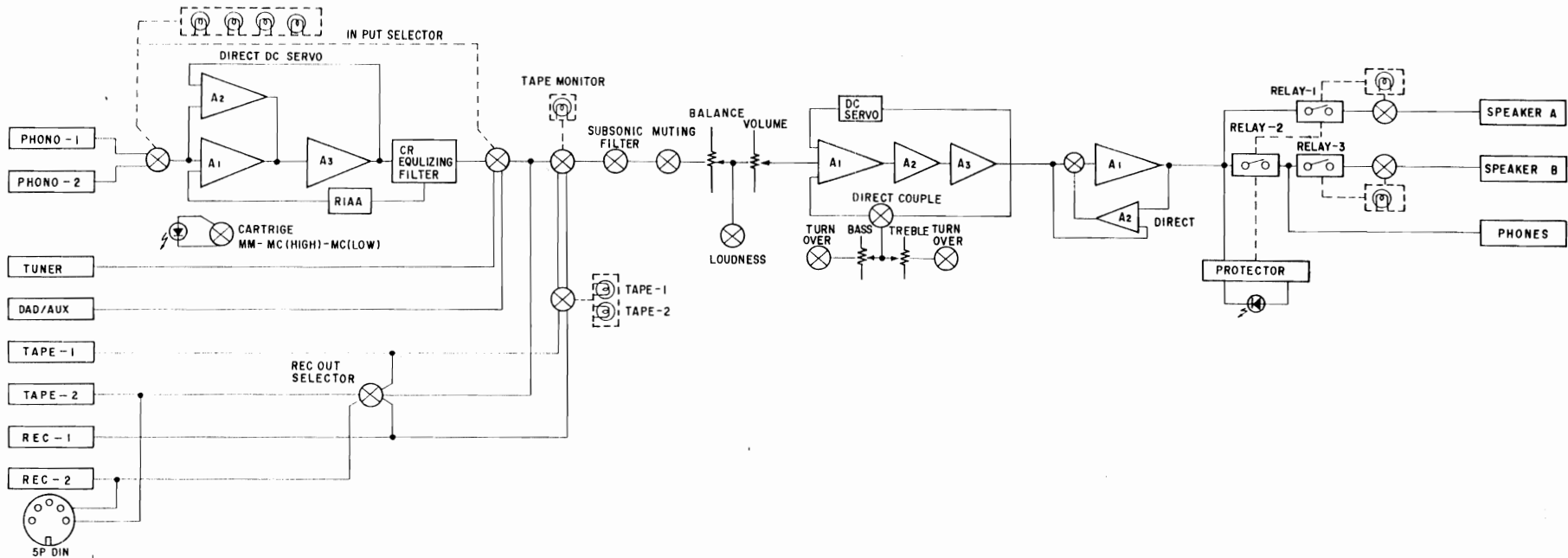

Fig. 3

METHOD OF ADJUSTMENTS

PUS0021B POWER AMPLIFIER UNIT

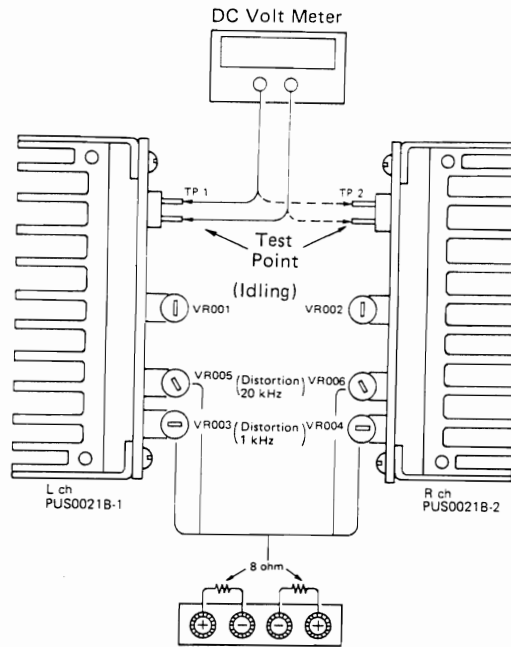

Fig. 4

ADJUSTMENT

IDLING CURRENT (Fig. 4)

○ SETUP

- 1 Lay the unit at an ordinary position away from a direct current from a cooler or fan. Do the adjustment at a temperature between 15°C and 30°C.
- 2 Set controls as follows.
 - POWER SWITCH → off.
 - VOLUME CONTROL → fully counterclockwise.
 - DIRECT COUPLE → direct
 - SPEAKER Terminals → open: do not connect the speakers, dummy load etc.

○ Adjustment

- 1 Remove Top cover and turn VR001 and VR002 of PUS0021B (Power Amp Unit) fully counterclockwise. And then connect DC Voltmeter to Test point (Lch TP1, Rch TP2).
- 2 Connect Power cord to AC outlet, and turn Power Switch "on" (■). Within 10 seconds turn VR001 and VR002 clockwise so that the DC voltmeter reads
 - 0.5 ± 0.2 mVDC
- 3 Then after 10 ~ 15 minutes warmup adjust VR001 and VR002 so that the DC Voltmeter reads
 - 15 ± 2 mVDC

DISTORTION

○ 1 kHz

- 1 Connect 8 ohm 1/4W resistor across SPEAKER terminal.
- 2 Apply 1 kHz sine wave to "TUNER" terminal, and adjust the input level so that 75W (245 Vms at 8 ohm resistor) is delivered at the 8Ω resistor. (at each L and Rch)
- 3 Adjust VR003 (Lch) and VR004 (Rch) for minimum distortion.
 - Note: Set VR005 and VR006 to center.

○ 20 kHz

- 1 Set as per 1 and 2 above mentioned, but apply 20 kHz Sine wave.
- 2 Adjust VR005 (Lch) and VR006 (Rch) for minimum distortion.
 - Note: Do the 20 kHz adjustment after 1 kHz adjustment completed.

ETC0556B INPUT & EQULIZER UNIT

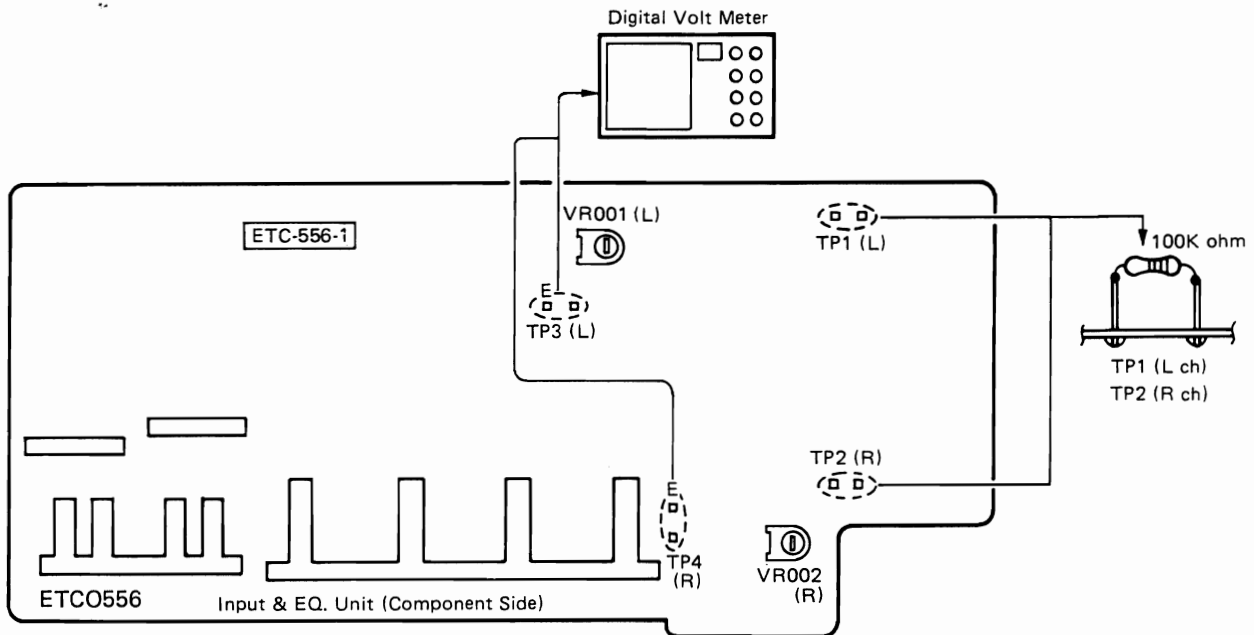

Fig. 5

NEUTRAL POINT

○ Setup

- 1 Insert short-pin to "PHONO" input terminal.
- 2 Connect Digital Voltmeter (0.01 ~ 1 mVDC measurable) to "REC" output terminal.
- 3 Connect 100kΩ (1/4W) resistor across Test point of the Unit (Lch TP-1, Rch TP-2). (To facilitate the measurement).
- 4 Set REC OUT SERECTOR to "PHONO-1" and Cartridge Switch to "MM" position, and turn Volume Control fully counterclockwise.

○ Adjustment (Be sure to set TAPE MONITOR Switch to "SOURCE")

- 1 Turn Power switch "on (—)" and after about 2 minutes do the adjustment as follows.
 - Adjust VR001 (100kΩ semi-fixed resistor) so that the Lch Digital Voltmeter reads below 0.5 mVDC.
 - Adjust VR002 (100kΩ semi-fixed resistor) so that the Rch Digital Voltmeter reads below 0.5 mVDC.

SEMICONDUCTORS

• IC

HA12002W

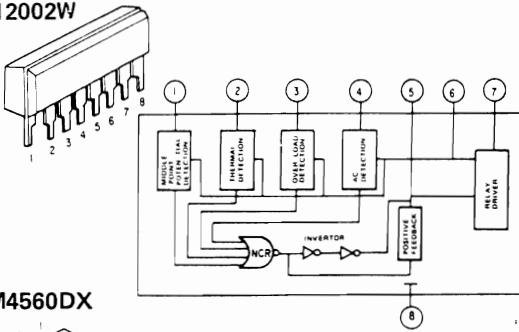

NJM4560DX

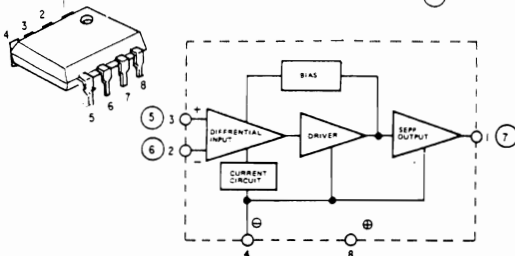

NJM78M20A

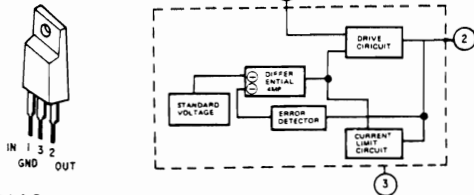

μPC741C

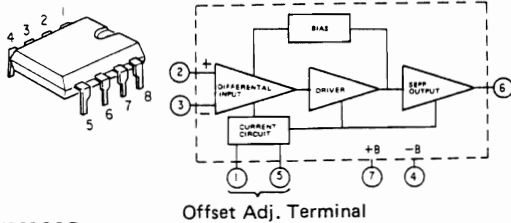

NJM082D

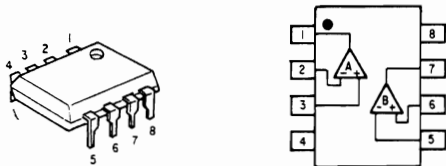

LA6458DS

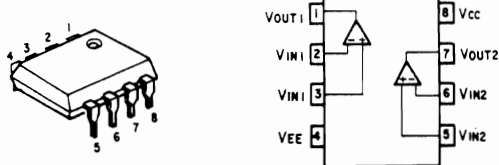

• TRANSISTOR(inciude FET)

2SC1815(BL),(Y)
2SC1841(F)/(E)
2SA1015(Y)

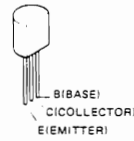

2SA1020(Y)

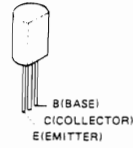

2SC2238(Y)---
2SA968(Y)
2SD880(Y)/(GR)

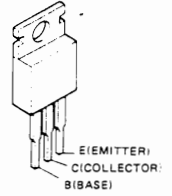

2SC1941(L)
2SA916(L)

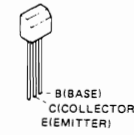

FET
2SK270A(BL)/(V)

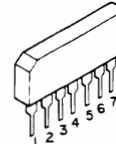

FET
2SK30A(R)/(O)

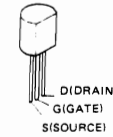

FET
2SK369(BL)/(V)

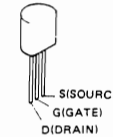

2SA1294(O)/(Y)
2SC3263(O)/(Y)

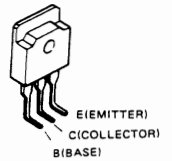

• DIODES(include LED,Thermistor & Posistor)

HZ-16-2
HZ-7B-3
HZ-15
HZ-30



KB-265



STV-1H

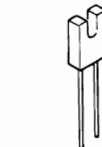

RB-152

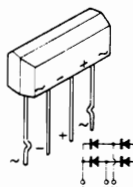

MZ-303A
MZ-304B

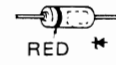

S2K20F

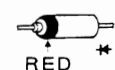

RB-602UFR

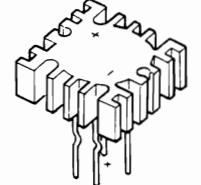

SEL1323G(Green)
SEL1123R(Red)

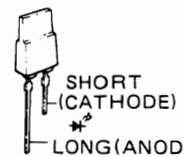

PTH487A01BD222TS

POSISTOR
YELLOW

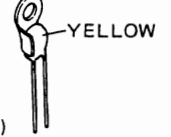

ETC0557B PARTS LIST

Ref. No.	Part No.	Part Name & Descriptions	
SEMICONDUCTORS			
TR001	2730198015	2SC1815(BL)	TRANSISTOR
TR002	2730198015	2SC1815(BL)	TRANSISTOR
TR003	2730198015	2SC1815(BL)	TRANSISTOR
TR004	2730198015	2SC1815(BL)	TRANSISTOR
TR005	2750036034	2SK270A(BL)/(V)/(GR)	FET
TR006	2750036034	2SK270A(BL)/(V)/(GR)	FET
TR007	2730235020	2SC1841(F)/(E)	TRANSISTOR
TR008	2730235020	2SC1841(F)/(E)	TRANSISTOR
TR009	2730235020	2SC1841(F)/(E)	TRANSISTOR
TR010	2730235020	2SC1841(F)/(E)	TRANSISTOR
TR011	2710110000	2SA916(L)	TRANSISTOR
TR012	2710110000	2SA916(L)	TRANSISTOR
TR013	2710110000	2SA916(L)	TRANSISTOR
TR014	2710110000	2SA916(L)	TRANSISTOR
TR015	2730199001	2SC2238(Y)	TRANSISTOR
TR016	2730199001	2SC2238(Y)	TRANSISTOR
TR017	2730205005	2SC1941(L)	TRANSISTOR
TR018	2730205005	2SC1941(L)	TRANSISTOR
TR019	2710104003	2SA968(Y)	TRANSISTOR
TR020	2710104003	2SA968(Y)	TRANSISTOR
D001	2760219003	HZ-15	ZENER
D003	2760244007	MZ303A	ZENER
D004	2760244007	MZ303A	ZENER
D005	2760219003	HZ-15	ZENER
D007	2760049008	1S2076	DIODE
D008	2760049008	1S2076	DIODE
D009	2760049008	1S2076	DIODE
D010	2760049008	1S2076	DIODE
D011	2760216019	KB-265	DIODE
D012	2760216019	KB-265	DIODE
D013	2760049008	1S2076	DIODE
D014	2760049008	1S2076	DIODE
D015	2760246005	RB152	DIODE
D017	2760049008	1S2076	DIODE
D018	2760049008	1S2076	DIODE
D019	2760254000	HZ7B-3	ZENER
D020	2760254000	HZ7B-3	ZENER
D021	2760254000	HZ7B-3	ZENER
D022	2760254000	HZ7B-3	ZENER
D023	2760049008	1S2076	DIODE
D024	2760049008	1S2076	DIODE
D025	2760049008	1S2076	DIODE
D026	2760049008	1S2076	DIODE
D035	2760210015	MZ304B	DIODE
D036	2760210015	MZ304B	DIODE
D037	2760210015	MZ304B	DIODE
D038	2760210015	MZ304B	DIODE
RESISTORS (not included Carbon Film ±5%, 1/4W Type)			
VR001	21 10349002	VARIABLE RESISTOR 100k ohm BALANCE	
VR002	21 10276007	VARIABLE RESISTOR 50k ohm MAIN	
VR003	21 10351003	VARIABLE RESISTOR 100k ohm BASS	
VR005	21 10350004	VARIABLE RESISTOR 50k ohm TREBLE	
R011	2420203003	10M ohm ±10%	1/4W CARBON COMPOSIT
R012	2420203003	10M ohm ±10%	1/4W CARBON COMPOSIT
R039	2412316092	3.3k ohm ±2%	1/4W CARBON FILM (FUSIBLE)
R040	2412316092	3.3k ohm ±2%	1/4W CARBON FILM (FUSIBLE)
R047	2412316092	3.3k ohm ±2%	1/4W CARBON FILM (FUSIBLE)
R048	2412316092	3.3k ohm ±2%	1/4W CARBON FILM (FUSIBLE)

Ref. No.	Part No.	Part Name & Descriptions			
R049	2440105026	3.9k ohm ±5%	2W	METAL OXIDE	
R057	2440105026	3.9k ohm ±5%	2W	METAL OXIDE	
R061	2410223006	39k ohm ±5%	1/2W	CARBON FILM	
R062	2410223006	39k ohm ±5%	1/2W	CARBON FILM	
R067	2412314036	750 ohm ±5%	1/4W	CARBON FILM (NON BURNING)	
R068	2412314036	750 ohm ±5%	1/4W	CARBON FILM (NON BURNING)	
R071	2412321005	1k ohm ±5%	1/4W	CARBON FILM (NON BURNING)	
R072	2412321005	1k ohm ±5%	1/4W	CARBON FILM (NON BURNING)	
R073	2412321005	1k ohm ±5%	1/4W	CARBON FILM (NON BURNING)	
R074	2412321005	1k ohm ±5%	1/4W	CARBON FILM (NON BURNING)	
R075	2412321045	220 ohm ±5%	1/4W	CARBON FILM (NON BURNING)	
R076	2412321045	220 ohm ±5%	1/4W	CARBON FILM (NON BURNING)	
R077	2412321016	22 ohm ±5%	1/4W	CARBON FILM (NON BURNING)	
R078	2412321016	22 ohm ±5%	1/4W	CARBON FILM (NON BURNING)	
R079	2412321016	22 ohm ±5%	1/4W	CARBON FILM (NON BURNING)	
R080	2412321016	22 ohm ±5%	1/4W	CARBON FILM (NON BURNING)	
R081	2412321016	22 ohm ±5%	1/4W	CARBON FILM (NON BURNING)	
R082	2412321016	22 ohm ±5%	1/4W	CARBON FILM (NON BURNING)	
R083	2440108023	6.8k ohm ±5%	2W	METAL OXIDE	
R084	2440108023	6.8k ohm ±5%	2W	METAL OXIDE	
R085	2412369049	430 ohm ±5%	1/4W	CARBON FILM (NON BURNING)	
R086	2412369049	430 ohm ±5%	1/4W	CARBON FILM (NON BURNING)	
R089	2412369049	430 ohm ±5%	1/4W	CARBON FILM (NON BURNING)	
R090	2412369049	430 ohm ±5%	1/4W	CARBON FILM (NON BURNING)	
R099	2412321016	22 ohm ±5%	1/4W	CARBON FILM (NON BURNING)	
R100	2412321016	22 ohm ±5%	1/4W	CARBON FILM (NON BURNING)	
CAPACITORS (not included Ceramic 50V Type)					
C001	2561030067	0.18μF ±5%	100V	METALIZED	
C002	2561030067	0.18μF ±5%	100V	METALIZED	
C003	2561030070	0.1μF ±5%	100V	METALIZED	
C004	2561030070	0.1μF ±5%	100V	METALIZED	
C005	2554142001	750pF ±5%	50V	PLASTIC FILM	
C006	2554142001	750pF ±5%	50V	PLASTIC FILM	
C007	2561030054	0.039μF ±5%	100V	METALIZED	
C008	2561030054	0.039μF ±5%	100V	METALIZED	
C009	2561030041	0.27μF ±5%	100V	METALIZED	
C010	2561030041	0.27μF ±5%	100V	METALIZED	
C011	2561030054	0.039μF ±5%	100V	METALIZED	
C012	2561030054	0.039μF ±5%	100V	METALIZED	
C013	2561030041	0.27μF ±5%	100V	METALIZED	
C014	2561030041	0.27μF ±5%	100V	METALIZED	
C015	2554127000	180pF ±5%	100V	PLASTIC FILM	
C016	2554127000	180pF ±5%	100V	PLASTIC FILM	
C017	2554147006	0.0012μF ±5%	50V	PLASTIC FILM	
C018	2554147006	0.0012μF ±5%	50V	PLASTIC FILM	
C019	2554159007	0.0039μF ±5%	50V	PLASTIC FILM	

ETC0557B, D CONTROL & LAMP UNIT

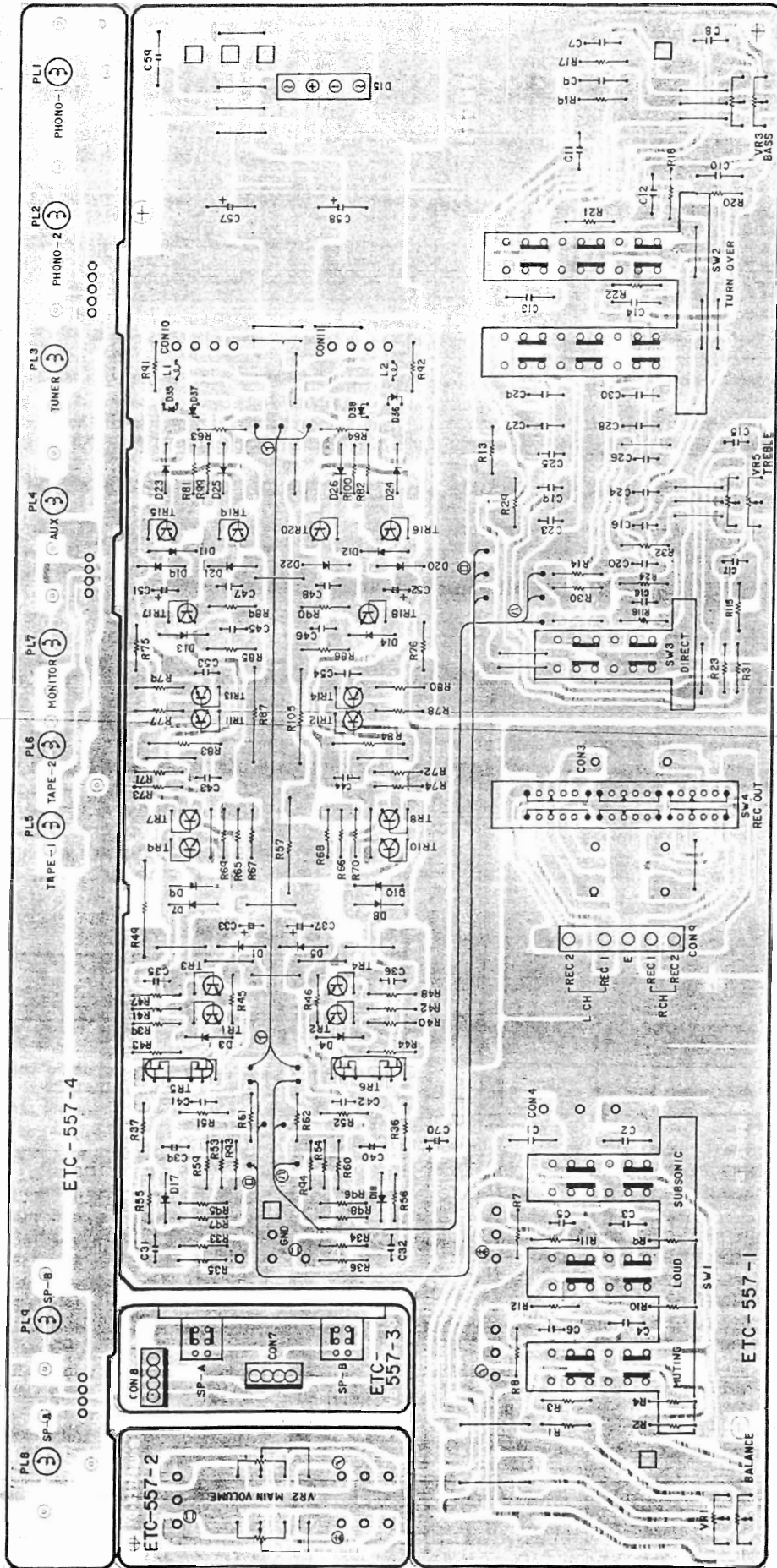

(Con.)

Ref. No.	Part No.	Part Name & Descriptions
C020	2554159007	0.0039 μ F \pm 5% 50V PLASTIC FILM
C023	2554159007	0.0039 μ F \pm 5% 50V PLASTIC FILM
C024	2554159007	0.0039 μ F \pm 5% 50V PLASTIC FILM
C025	2554157009	0.0033 μ F \pm 5% 50V PLASTIC FILM
C026	2554157009	0.0033 μ F \pm 5% 50V PLASTIC FILM
C027	2554181004	0.033 μ F \pm 5% 50V PLASTIC FILM
C028	2554181004	0.033 μ F \pm 5% 50V PLASTIC FILM
C029	2554177005	0.022 μ F \pm 5% 50V PLASTIC FILM
C030	2554177005	0.022 μ F \pm 5% 50V PLASTIC FILM
C031	2556085001	270pF \pm 5% 50V PLASTIC FILM
C032	2556085001	270pF \pm 5% 50V PLASTIC FILM
C033	2544038002	100 μ F \pm 10% 35V ELECTROLYTIC
C035	2554157009	0.0033 μ F \pm 5% 50V PLASTIC FILM
C036	2554157009	0.0033 μ F \pm 5% 50V PLASTIC FILM
C037	2544038002	100 μ F \pm 20% 35V ELECTROLYTIC
C039	2543016083	22 μ F \pm 20% 50V ELECTROLYTIC (B.P)
C040	2543016083	22 μ F \pm 20% 50V ELECTROLYTIC (B.P)
C041	2521003005	3pF \pm 0.25pF 50V MICA
C042	2521003005	3pF \pm 0.25pF 50V MICA
C043	2554084059	820pF \pm 5% 100V PLASTIC FILM
C044	2554084059	820pF \pm 5% 100V PLASTIC FILM
C045	2554145008	0.001 μ F \pm 5% 50V PLASTIC FILM
C046	2554145008	0.001 μ F \pm 5% 50V PLASTIC FILM
C047	2554139001	560pF \pm 5% 50V PLASTIC FILM
C048	2554139001	560pF \pm 5% 50V PLASTIC FILM
C051	2544181014	10 μ F \pm 20% 100V ELECTROLYTIC
C052	2544181014	10 μ F \pm 20% 100V ELECTROLYTIC
C053	2521081027	3pF \pm 0.5pF 500V MICA
C054	2521081027	3pF \pm 0.5pF 500V MICA
C057	2546070000	1000 μ F \pm 20% 80V ELECTROLYTIC
C058	2546070000	1000 μ F \pm 20% 80V ELECTROLYTIC
C059	2561017019	0.01 μ F \pm 10% 630V METALIZED
C063	2521008000	8pF \pm 0.5pF 50V MICA
C064	2521008000	8pF \pm 0.5pF 50V MICA
C070	2544132005	10 μ F \pm 20% 16V ELECTROLYTIC
C073	2554131009	270pF \pm 5% 50V PLASTIC FILM
C074	2554131009	270pF \pm 5% 50V PLASTIC FILM
C075	2554127000	180pF \pm 5% 50V PLASTIC FILM
C076	2554127000	180pF \pm 5% 50V PLASTIC FILM

SWITCH

SW001	2124289006	3P PUSH SWITCH FOR MUT. LOUD
SW002	2124401004	2P PUSH SWITCH FOR TURNOVER
SW003	2124288007	1P PUSH SWITCH FOR DIRECT
SW004	2120216002	ROTARY SWITCH FOR RECOUT
SW005	2124400005	2P PUSH SWITCH FOR SP

COILS

L001	2350008006	INDUCTOR 22mH
L002	2350008006	INDUCTOR 22mH
PILOT LAMPS		
PL001 ~009	3930083000	PILOT LAMP 16V 0.04A

OTHER PARTS

2220876106	P.W. BOARD
2090047903	0.6 JUMPER WIRE USED 33
2050134908	TERMINAL PIN USED 6
2090008104	JUMPER P=15mm USED 2
2050122059	5P CONNECTOR BASE
2050133048	4P NH CONNECTOR BASE USED 2

Ref. No.	Part No.	Part Name & Descriptions
	4530022208	LAMP COVER (A) USED 7
	4530023207	LAMP COVER (B)
	2036099012	4P CONNECTOR CORD FOR LCH
	2036099009	4P CONNECTOR CORD FOR RCH
	2038109036	5P CONNECTOR CORD FOR LAMP
	2038114005	5P CONNECTOR CORD FOR LAMP
	2038113006	5P CONNECTOR CORD FOR LAMP
	2036086177	4P CONNECTOR CORD FOR LAMP
	2090008120	JUMPER P=10mm USED 2
	4170204004	RADIATOR USED 4
	4450033005	WIRE CLAMP BAND USED 4

ETC0557D PARTS LIST

All parts except not listed are same as ETC0557B.

Ref. No.	Part No.	Part Name & Descriptions
CAPACITORS		
C035	2556099000	0.001 μ F \pm 50% 50V PLASTIC FILM (Change)
C036	2556099000	0.001 μ F \pm 50% 50V PLASTIC FILM (Change)

ETC0558B, D POWER SUPPLY & PROTECTOR UNIT

This units E1 only.

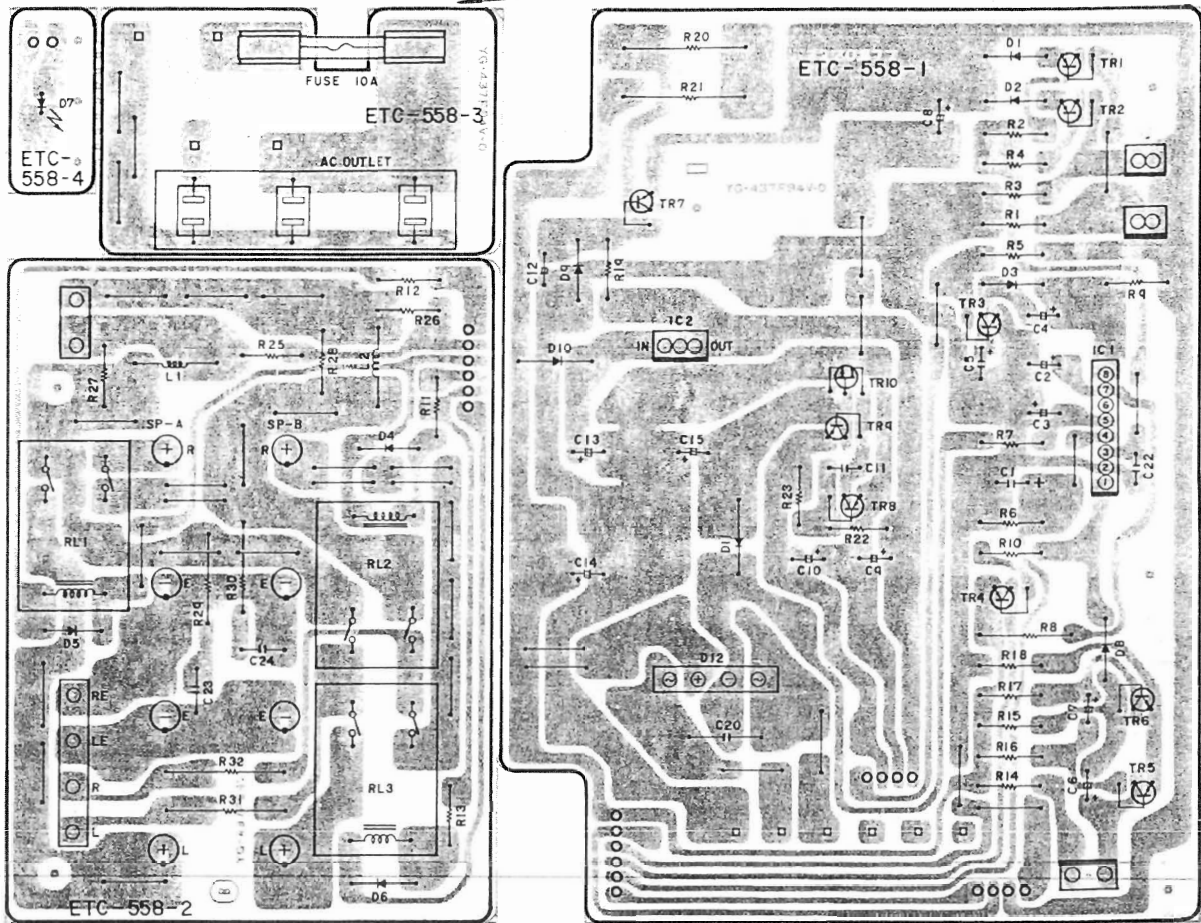

ETC0058B PARTS LIST

Ref. No.	Part No.	Part Name & Descriptions	
SEMICONDUCTORS			
IC001	2630102004	HA12002W	I.C.
IC002	2630243002	NJM78M20A	I.C.
TR001	2710102005	2SA1015(Y)	TRANSISTOR
TR002	2710102005	2SA1015(Y)	TRANSISTOR
TR003	2730198015	2SC1815(BL)	TRANSISTOR
TR004	2710102005	2SA1015(Y)	TRANSISTOR
TR005	2730198015	2SC1815(BL)	TRANSISTOR
TR006	2730198015	2SC1815(BL)	TRANSISTOR
TR007	2740065044	2SD880(Y)/(GR)	TRANSISTOR
TR008	2710102005	2SA1015(Y)	TRANSISTOR
TR009	2710117003	2SA1020(Y)	TRANSISTOR
TR010	2750043001	2SK3B1(B)/(C)	FET
D001	2760244007	MZ303A	ZENER
D002	2760244007	MZ303A	ZENER
D003	2760244007	MZ303A	ZENER
D004	2760049008	1S2076	DIODE
D005	2760049008	1S2076	DIODE
D006	2760049008	1S2076	DIODE
D007	3939165013	SEL1123R(RED)	LED
D008	2760049008	1S2076	DIODE
D009	2760256008	HZ-16-2	ZENER
D010	2760348000	S2K20F	DIODE
D011	2760348000	S2K20F	DIODE
D012	2760246005	RB152	DIODE

Ref. No.	Part No.	Part Name & Descriptions			
RESISTORS (not included Carbon Film ±5%, 1/4W Type)					
R008	2440042024	1.2k ohm	±5%	1W	METAL OXIDE
R011	2412369023	130 ohm	±5%	1/4W	CARBON FILM (NON BURNING)
R012	2412369023	130 ohm	±5%	1/4W	CARBON FILM (NON BURNING)
R013	2412369036	160 ohm	±5%	1/4W	CARBON FILM (NON BURNING)
R014	2410185005	1k ohm	±5%	1/2W	CARBON FILM
R019	2412314023	470 ohm	±5%	1/4W	CARBON FILM (NON BURNING)
R020	2440075020	12 ohm	±5%	2W	METAL OXIDE
R021	2440075020	12 ohm	±5%	2W	METAL OXIDE
R029	2440021029	22 ohm	±5%	1W	METAL OXIDE
R030	2440021029	22 ohm	±5%	1W	METAL OXIDE
R031	2440087021	120 ohm	±5%	2W	METAL OXIDE
R032	2440087021	120 ohm	±5%	2W	METAL OXIDE
CAPACITORS (not included Ceramic 50V Type)					
C001	2544127007	220µF	±20%	6.3V	ELECTROLYTIC
C002	2544140000	4.7µF	±20%	35V	ELECTROLYTIC
C003	2544147003	2.2µF	±20%	50V	ELECTROLYTIC
C004	2544130007	100µF	±20%	10V	ELECTROLYTIC
C005	2549015004	22µF	±10%	10V	ELECTROLYTIC

PUS0021B PARTS LIST

Con.)

Ref. No.	Part No.	Part Name & Descriptions
C030	2531036004	0.0047μF ±10% 50V CERAMIC
033		
C006	2544140000	4.7μF ±20% 35V ELECTROLYTIC
C007	2544140000	4.7μF ±20% 35V ELECTROLYTIC
C008	2544089006	1μF ±20% 50V ELECTROLYTIC
C009	2544089006	1μF ±20% 50V ELECTROLYTIC
C010	2544089006	1μF ±20% 50V ELECTROLYTIC
C011	2521026008	47pF ±5% 50V MICA
C012	2544141009	10μF ±20% 35V ELECTROLYTIC
C013	2544159017	1000μF ±20% 35V ELECTROLYTIC
C014	2544159017	1000μF ±20% 35V ELECTROLYTIC
C015	2544159017	1000μF ±20% 35V ELECTROLYTIC
C020	2561017019	0.01μF ±10% 630V METALIZED
C022	2531024003	0.01μF +80,-20% 50V CERAMIC
C023	2554177005	0.022μF ±5% 50V PLASTIC FILM
C024	2554177005	0.022μF ±5% 50V PLASTIC FILM

RELAYS

RL001	2140041008	RELAY
RL002	2140041008	RELAY
RL003	2140041008	RELAY
COILS		
L001	2350007007	INDUCTOR 1μH
L002	2350007007	INDUCTOR 1μH

OTHER PARTS

2220877008	P.W. BOARD
2090047903	0.6 JUMPER WIRE USED 35
2050173008	8P TERMINAL FOR SP
2050075025	2P TERMINAL
2050075041	WRAP TERMINAL
2050133022	2P NH CONNECTOR BASE USED 2
2050133035	3P NH CONNECTOR BASE USED 1
2050075067	6P WRAPPING TERMINAL
4170140100	RADIATOR
4730354019	TAPPING SCREW (2) 3x8 USED 2
2034185012	3P CONNECTOR CORD
2036086151	4P CONNECTOR CORD FOR LAMP
2036086164	4P CONNECTOR CORD FOR EQ
2090008120	JUMPER (SHORT LEAD) P=10mm USED 2

Ref. No.	Part No.	Part Name & Descriptions
SEMICONDUCTORS		
IC001	2630244001	NJM082D I.C.
IC002	2630244001	NJM082D I.C.
IC003	2630229000	LA6458DS I.C.
IC004	2630229000	LA6458DS I.C.
TR001	2730198015	2SC1815(BL) TRANSISTOR
TR002	2730198015	2SC1815(BL) TRANSISTOR
TR003	2730205005	2SC1941(L) TRANSISTOR
TR004	2730205005	2SC1941(L) TRANSISTOR
TR005	2710110000	2SA916(L) TRANSISTOR
TR006	2710110000	2SA916(L) TRANSISTOR
TR007	2730199001	2SC2238(Y) TRANSISTOR
TR008	2730199001	2SC2238(Y) TRANSISTOR
TR009	2710104003	2SA968(Y) TRANSISTOR
TR010	2710104003	2SA968(Y) TRANSISTOR
TR011	2730198002	2SC1815(Y) TRANSISTOR
TR012	2730198002	2SC1815(Y) TRANSISTOR
TR013	2710102005	2SA1015(Y) TRANSISTOR
TR014	2710102005	2SA1015(Y) TRANSISTOR
TR021	2730198002	2SC1815(Y) TRANSISTOR
TR022	2730198002	2SC1815(Y) TRANSISTOR
TR023	2710102005	2SA1015(Y) TRANSISTOR
TR024	2710102005	2SA1015(Y) TRANSISTOR
TR025	2710102005	2SA1015(Y) TRANSISTOR
TR026	2710102005	2SA1015(Y) TRANSISTOR
TR027	2730198002	2SC1815(Y) TRANSISTOR
TR028	2730198002	2SC1815(Y) TRANSISTOR
D001	2760254000	HZ7B-3 ZENER
~004		
D005	2760049008	1S2076 DIODE
~008		
D013	2760334001	STV-1H DIODE
D014	2760334001	STV-1H DIODE
D015	2760049008	1S2076 DIODE
~022		
D023, 024	2760350001	S1R20F DIODE
D027	2760216019	KB-265 DIODE
~030		
D031	2760350001	S1R20F DIODE
D032	2760350001	S1R20F DIODE
D035	2760254000	HZ7B-3 ZENER
~038		
D039	2760049011	1S2076A DIODE
D040	2760049011	1S2076A DIODE
D041	2760049011	1S2076A DIODE
D042	2760049011	1S2076A DIODE
D043	2760356005	D5FB20 DIODE
D045	2760337008	KB-462 DIODE
~048		
R101	2760289004	PTH487A01BD222TS POSISTOR
R102	2760289004	PTH487A01BD222TS POSISTOR

RESISTORS (not included Carbon Film ±5%, 1/4W Type)

VR001	2116014072	SEMI FIXED RESISTOR 10k ohm
VR002	2116014072	SEMI FIXED RESISTOR 10k ohm
VR003	2116014001	SEMI FIXED RESISTOR 100 ohm
VR004	2116014001	SEMI FIXED RESISTOR 100 ohm
VR005	2116014069	SEMI FIXED RESISTOR 200 ohm
VR006	2116014069	SEMI FIXED RESISTOR 200 ohm
R001	2440106025	4.7k ohm ±5% 1/4W CARBON FILM
R002	2440106025	4.7k ohm ±5% (NON BURNING)
R003	2412369007	820 ohm ±5% 1/4W CARBON FILM
R004	2412369007	820 ohm ±5% (NON BURNING)
R007	2440106025	4.7k ohm ±5% 2W METAL OXIDE
R008	2440106025	4.7k ohm ±5% 2W METAL OXIDE

(Con.)

Ref. No.	Part No.	Part Name & Descriptions		
R009 ~016 R023	2412369052	2.2k ohm ±5%	1/4W CARBON FILM (NON BURNING)	
R024	2412321003	1k ohm ±5%	1/4W CARBON FILM (NON BURNING)	
R025	2412314007	100 ohm ±5%	1/4W CARBON FILM (NON BURNING)	
R026	2412314007	100 ohm ±5%	1/4W CARBON FILM (NON BURNING)	
R027	2412321003	1k ohm ±5%	1/4W CARBON FILM (NON BURNING)	
R028	2412321003	1k ohm ±5%	1/4W CARBON FILM (NON BURNING)	
R031	2440029021	100 ohm ±5%	1W METAL OXIDE	
R032	2440029021	100 ohm ±5%	1W METAL OXIDE	
R033	2412321003	1k ohm ±5%	1/4W CARBON FILM (NON BURNING)	
R034	2412321003	1k ohm ±5%	1/4W CARBON FILM (NON BURNING)	
R035	2412314007	100 ohm ±5%	1/4W CARBON FILM (NON BURNING)	
R036	2412314007	100 ohm ±5%	1/4W CARBON FILM (NON BURNING)	
R037 ~040 R041	2412370054	10k ohm ±5%	1/4W CARBON FILM (NON BURNING)	
R042	2440158028	2.7k ohm ±5%	3.15W METAL OXIDE	
R043	2412369078	4.7k ohm ±5%	1/4W CARBON FILM (NON BURNING)	
R044	2412369078	4.7k ohm ±5%	1/4W CARBON FILM (NON BURNING)	
R045	2412369052	2.2k ohm ±5%	1/4W CARBON FILM (NON BURNING)	
R046	2412369052	2.2k ohm ±5%	1/4W CARBON FILM (NON BURNING)	
R047 ~050 R051	2412321003	1k ohm ±5%	1/4W CARBON FILM (NON BURNING)	
R052	2412369052	2.2k ohm ±5%	1/4W CARBON FILM (NON BURNING)	
R053	2412369078	4.7k ohm ±5%	1/4W CARBON FILM (NON BURNING)	
R054	2412369078	4.7k ohm ±5%	1/4W CARBON FILM (NON BURNING)	
R055	2410212004	13k ohm ±5%	1/2W CARBON FILM	
R056	2410212004	13k ohm ±5%	1/2W CARBON FILM	
R057	2440158028	2.7k ohm ±5%	3.15W METAL OXIDE	
R058	2440158028	2.7k ohm ±5%	3.15W METAL OXIDE	
R059	2410212004	13k ohm ±5%	1/2W CARBON FILM	
R060	2410212004	13k ohm ±5%	1/2W CARBON FILM	
R061 ~064 R067 ~074 R079 ~082 R083 ~090 R093 ~096 R097	2412321032	4.7 ohm ±5%	1/4W CARBON FILM (FUSIBLE)	
R098	2412321016	22 ohm ±5%	1/4W CARBON FILM (NON BURNING)	
R111 112	2432033038	0.18/0.18 ohm	1/4W CARBON FILM (NON BURNING)	
	2412321016	22 ohm ±5%	2W WIRE WOUND	
	2412321032	4.7 ohm ±5%	1/4W CARBON FILM (NON BURNING)	
	2440021029	22 ohm ±5%	1/4W CARBON FILM (NON BURNING)	
	2440021029	22 ohm ±5%	1W METAL OXIDE	
	2412369007	820 ohm ±5%	CARBON FILM (NON BURNING)	

Ref. No.	Part No.	Part Name & Descriptions			
CAPACITORS (not included Ceramic 50V, ±5%, ±10% Type)					
C001 ~004	2544181014	10µF	±20%	100V	ELECTROLYTIC
C005	2544089006	1µF	±20%	50V	ELECTROLYTIC
C006	2544089006	1µF	±20%	50V	ELECTROLYTIC
C007	2521022002	33pF	±5%	50V	MICA
C008	2521022002	33pF	±5%	50V	MICA
C009	2544180002	47µF	±20%	63V	ELECTROLYTIC
C010	2544180002	47µF	±20%	63V	ELECTROLYTIC
C011 ~014	2554137003	470pF	±5%	50V	PLASTIC FILM
C015	2554137003	470pF	±5%	50V	PLASTIC FILM
C016	2554137003	470pF	±5%	50V	PLASTIC FILM
C017	2544181001	1µF	±20%	100V	ELECTROLYTIC
C018	2544181001	1µF	±20%	100V	ELECTROLYTIC
C019	2554137003	470pF	±5%	50V	PLASTIC FILM
C020	2554137003	470pF	±5%	50V	PLASTIC FILM
C021	2554149004	0.0015µF	±5%	50V	PLASTIC FILM
C022	2554149004	0.0015µF	±5%	50V	PLASTIC FILM
C023	2554084017	0.01µF	±5%	100V	PLASTIC FILM
C024	2554084017	0.01µF	±5%	100V	PLASTIC FILM
C025	2554149004	0.0015µF	±5%	50V	PLASTIC FILM
C026	2554149004	0.0015µF	±5%	50V	PLASTIC FILM
C027	2544181014	10µF	±20%	100V	ELECTROLYTIC
C028	2544181014	10µF	±20%	100V	ELECTROLYTIC
C029	2554161008	0.0047µF	±5%	50V	PLASTIC FILM
C030	2554161008	0.0047µF	±5%	50V	PLASTIC FILM
C031 ~034 C035	2554137003	470pF	±5%	50V	PLASTIC FILM
C036	2554161008	0.0047µF	±5%	50V	PLASTIC FILM
C037 ~040 C041	2521079039	47pF	±10%	500V	MICA
C042	2554169000	0.01µF	±5%	50V	PLASTIC FILM
C043 ~046 C047	2544181001	1µF	±20%	100V	ELECTROLYTIC
C048	2544181014	10µF	±20%	100V	ELECTROLYTIC
C049	2554169000	0.01µF	±5%	50V	PLASTIC FILM
C050	2554169000	0.01µF	±5%	50V	PLASTIC FILM
C051 ~056 C057	2544181001	1µF	±20%	100V	ELECTROLYTIC
C059	2561017019	0.01µF	±10%	630V	METALIZED
C060	2554137003	470pF	±5%	50V	PLASTIC FILM
C061 ~064 C065	2521079071	22pF	±10%	500V	MICA
C066	2554137003	470pF	±5%	50V	PLASTIC FILM
C067 ~070	2554177005	0.022µF	±5%	50V	PLASTIC FILM
OTHER PARTS					
	2220874108	P.W. BOARD			
	2090047903	0.6 JUMPER WIRE USED 77			
	2050134908	TERMINAL PIN USED 6			
	2050075025	2P TERMINAL USED 2			
	2050122046	4P CONNECTOR PIN ASS'Y USED 2			
	EP-6071	BASE PIN USED 6			
	4410326008	HOLDER (RH-14) USED 4			
	4711304017	PAN SCREW 3x8 USED 4			
	4756006008	NUT M3 USED 4			
	2032095120	2P CONNECTOR CORD			
	2032108017	2P CONNECTOR CORD			

PUS0021B, D POWER AMP & POWER SOURCE UNIT

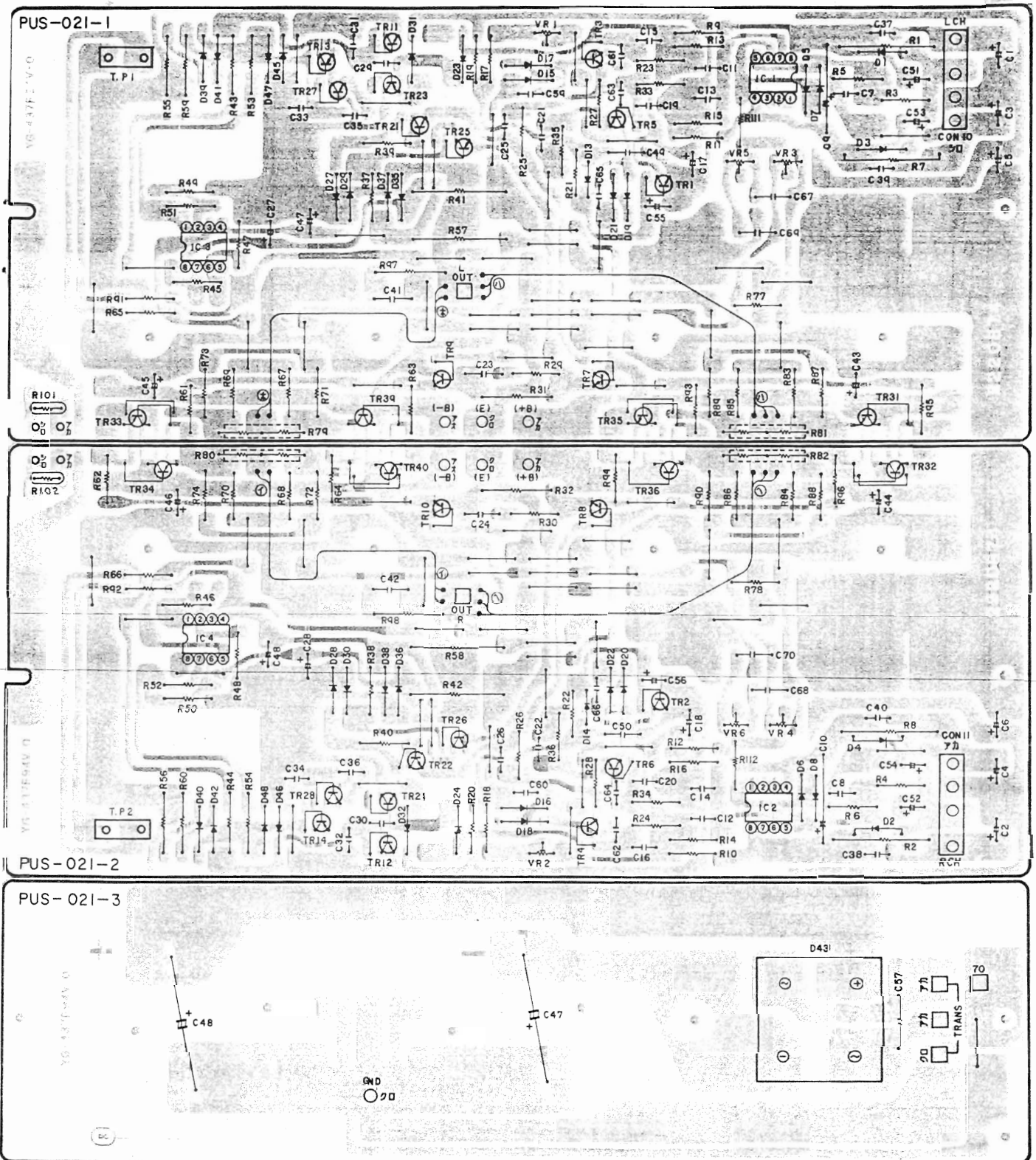

CONNECTION DIAGRAM

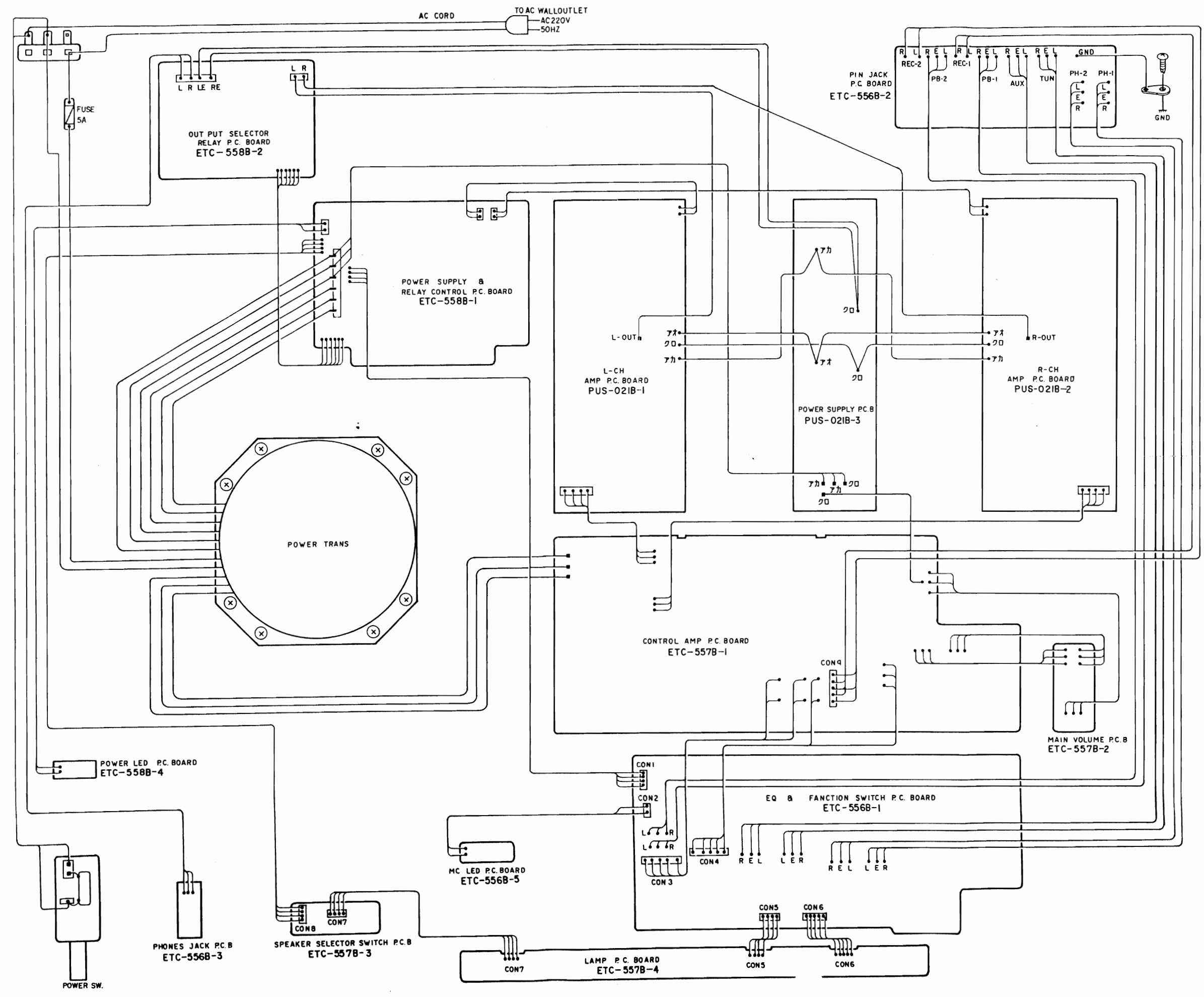

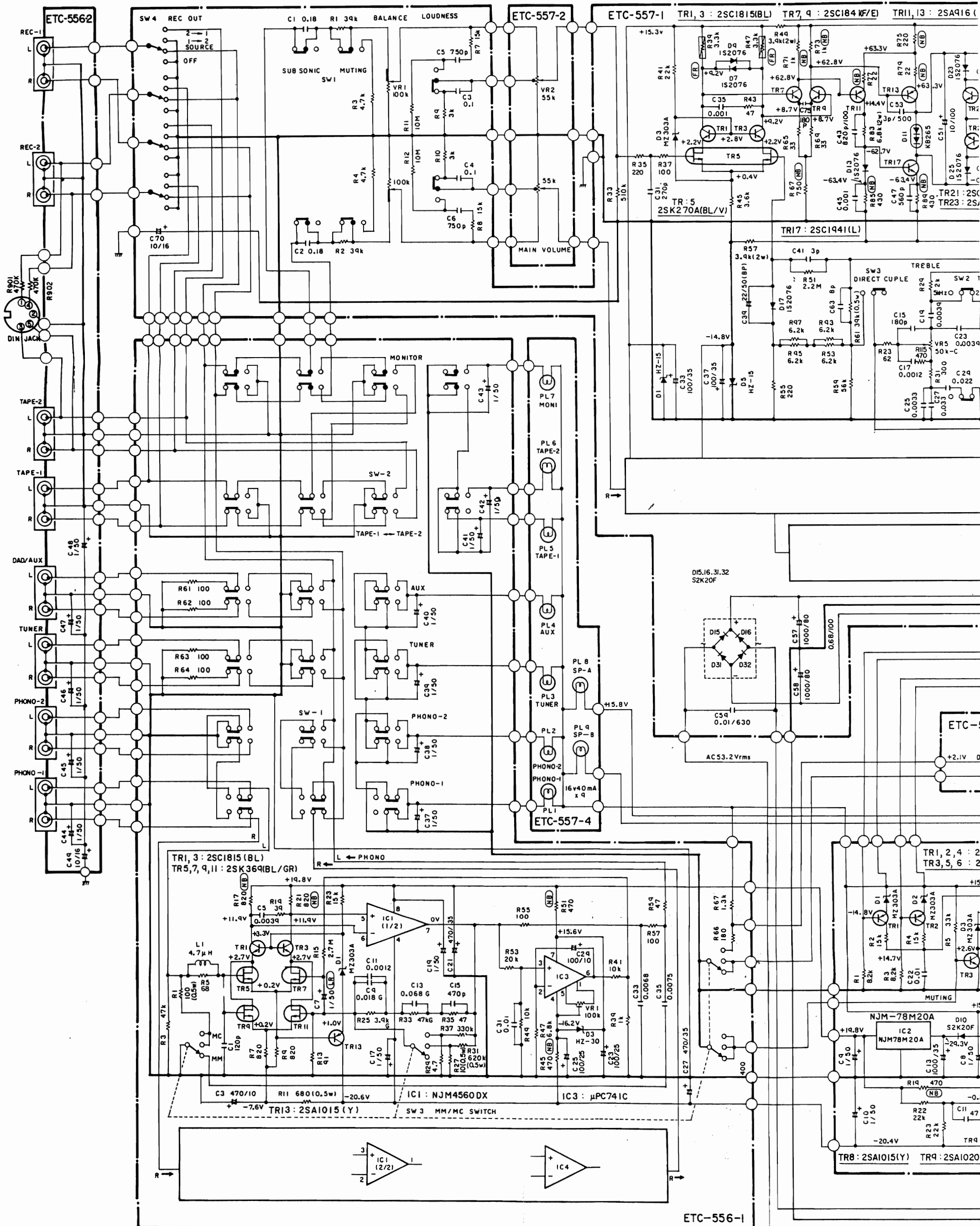

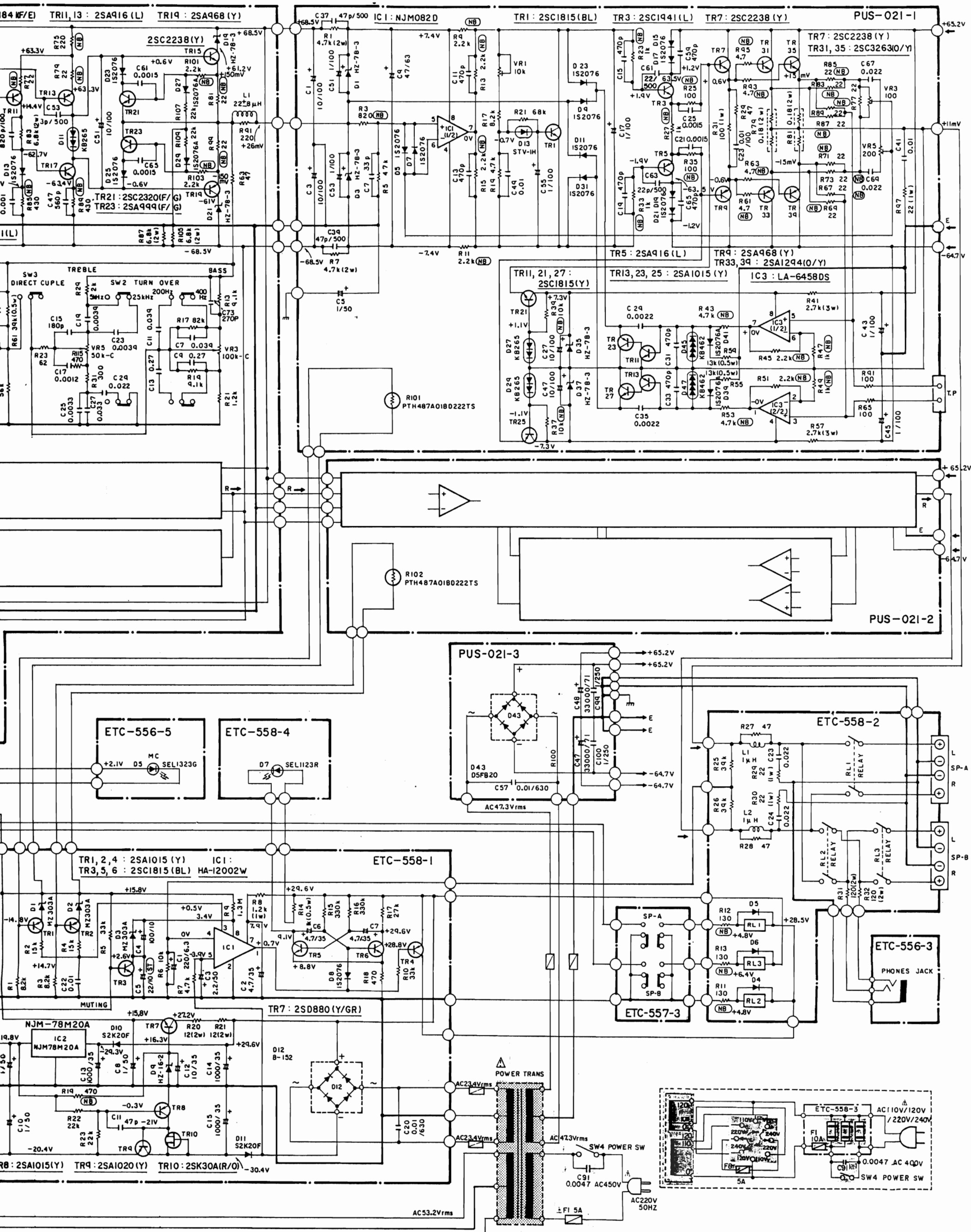

NOTES:
 ALL RESISTANCE VALUES IN OHM, K = 1,000 OHM, M = 1,000,000 OHM.
 ALL CAPACITANCE VALUES IN MICROFARAD, P = MICRO-MICRO FARAD.
 EVERY VOLTAGES AND CURRENTS IS MEASURED AT NO SIGNAL INPUT CONDITION.
 CIRCUIT AND PARTS ARE SUBJECT TO CHANGE WITHOUT PRIOR NOTICE.

EXPLODED VIEW OF CHASSIS AND CABINET

⚠ Means important safety item, which must be replaced, when necessary, by a part specified or meeting the specification by the manufacturer.

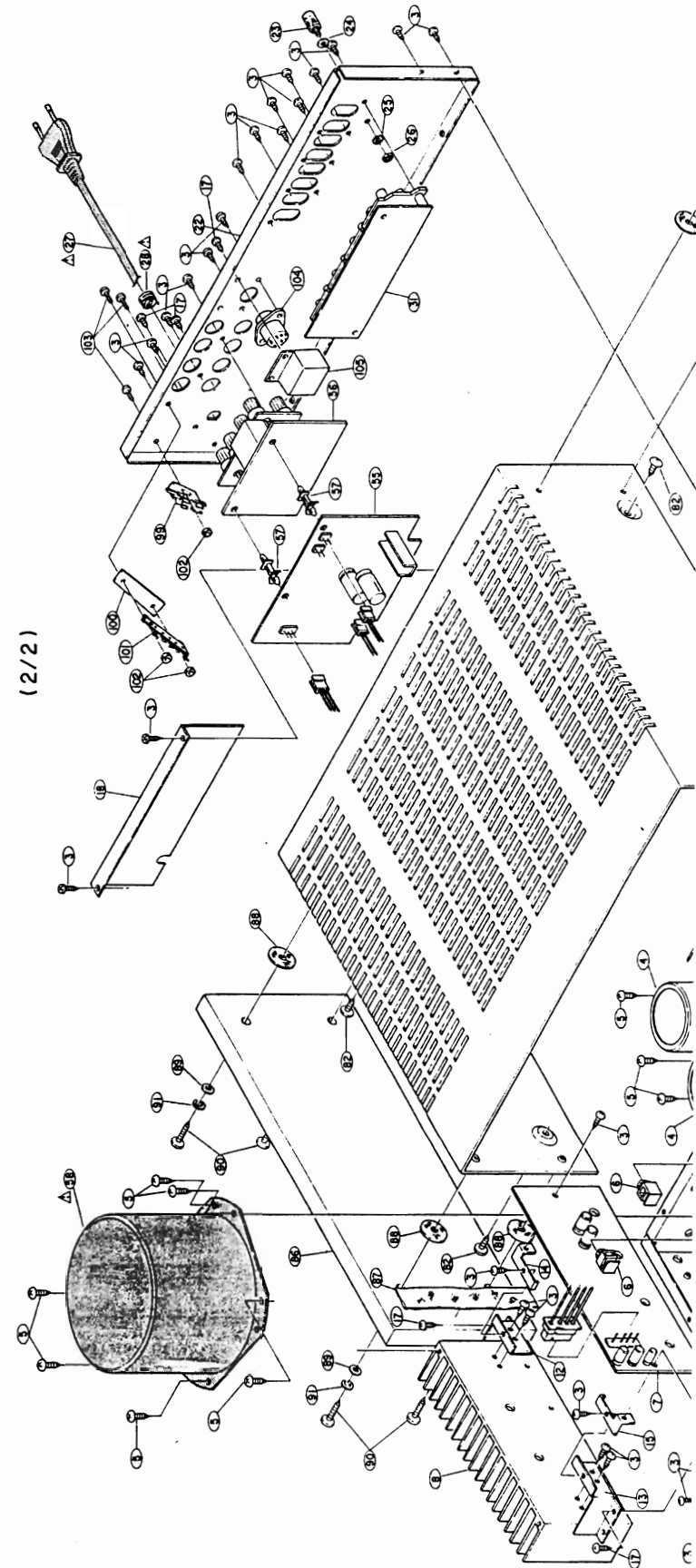
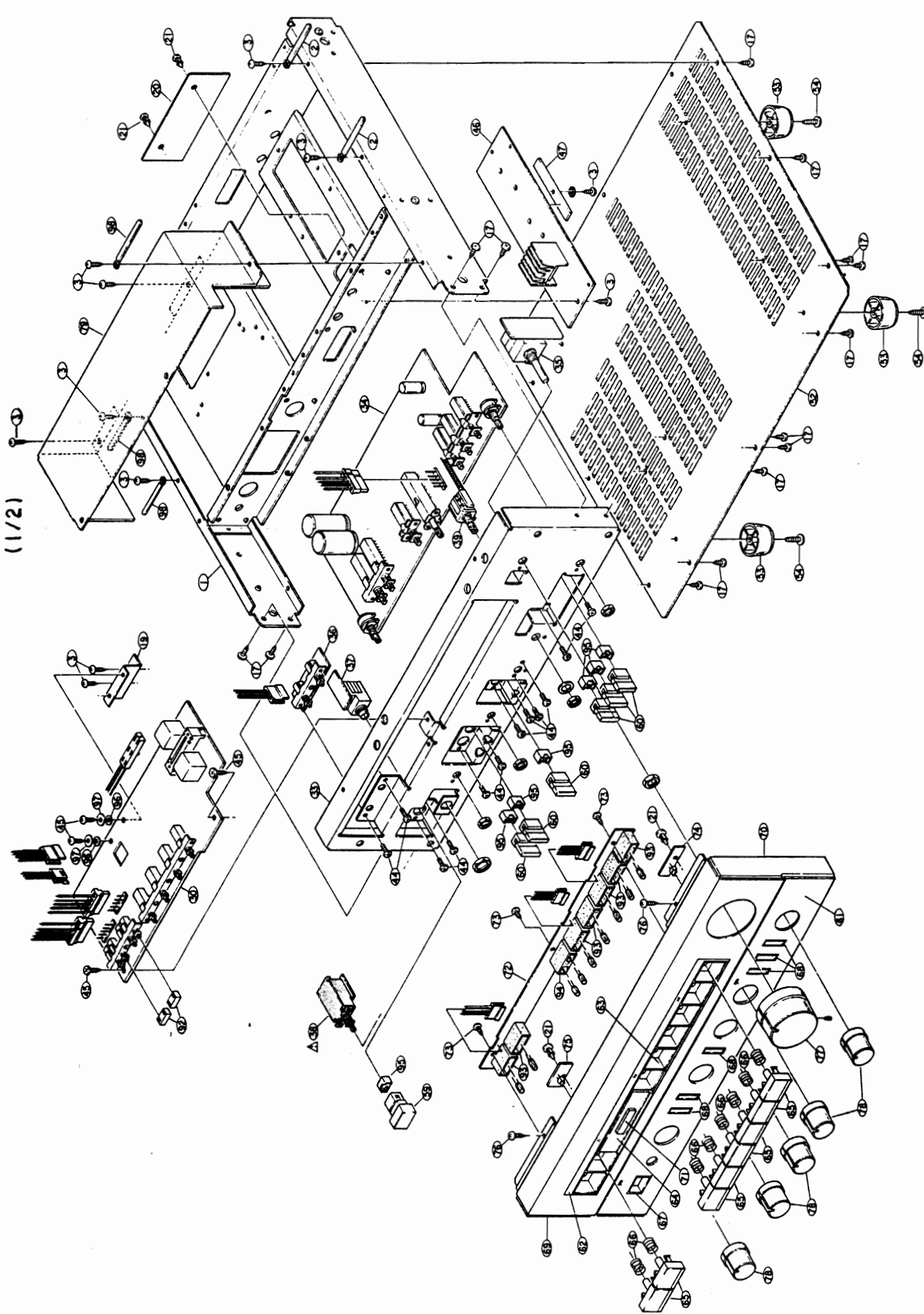

EXPLODED VIEW OF CHASSIS AND CABINET PARTS LIST

NOTE: 1. See addendum list below for the parts with asterisk (*) on the Ref. No. and the other parts not included in the list.
2. This list is prepared based on E2.

Ref. No.	Part No.	Part Name & Descriptions
1	4110372103	CHASSIS ASS'Y
2	EP-4772	CORD HOLDER USED 2
3	4730354035	TAPPING SCREW (2) 3x8 (BLACK)
4	2546050004	CHEMICON 33000μF/71V
5	4730455031	TAPPING SCREW (2) 4x10 (BLACK)
6	4150103002	P.C.B. HOLDER
*7	PUS0021B-1	POWER (L) UNIT
8	4170185000	POWER RADIATOR
9	2710164108	TRANSISTOR 2SA1294(O)/(Y)
10	2730278100	TRANSISTOR 2SC3263(O)/(Y)
11	4700012022	PAN SCREW WITH W.S.W 3x12
12	4120871005	RADIATOR BRACKET (A)
13	4120872004	RADIATOR BRACKET (B)
14	4120873003	BRACKET (A)
15	4120874002	BRACKET (B)
*16	PUS0021B-2	POWER AMP (R) UNIT
17	4770064107	FIXING SCREW
18	4140281002	SHIELD BRACKET
19	4121202000	BRACKET
20	4140277003	SHIELD PLATE (A)
21	4770096007	PUSH RIVET
*22	1050548003	BACK PANEL
23	2050043109	GND TERMINAL
24	4770088002	WASHER φ4.1 (NI)
25	4753100004	TOOTH WASHER φ4 (NI)
26	4770006000	NUT M4 (NI)
*30	ETC0556B-2	EQ. UNIT
*31	ETC0056B-2	INPUT UNIT
*32	4450033005	WIRE CLAMP BAND (USED 26)
33	4110373209	FRONT CHASSIS
*34	ETC0557B-1	CONTROL UNIT

Ref. No.	Part No.	Part Name & Descriptions
*35	ETC0557B-2	VOLUME UNIT
*36	ETC0557B-3	SP. SWITCH UNIT
*37	ETC0556B-3	HEAD PHONE UNIT
39	2120217001	ROTARY REMOTE SWITCH
40	-	NUT M7 (SP)
41	-	NUT M8 (SP)
42	-	NUT M9 (SP)
43	-	TOOTH WASHER φ9 (SP)
44	4711303018	PAN SCREW 3x6
45	4730354019	TAPPING SCREW (2) 3x8
46	PUS0021B-3	P.S. UNIT
47	2050169009	EARTH PLATE
48	4752003005	SPRING WASHER φ3
49	2538003014	CERAMIC CAP. 4700pF 400V
50	4150088004	INSULATING SHEET
51	2050089008	7P W. TERMINAL
52	1050308308	BOTTOM COVER
53	1040027107	FOOT
54	4730459011	TAPPING SCREW (2) 4x16
*55	ETC0558B-1	P.S SUPPLY UNIT
*56	ETC0558B-2	PROTECTOR UNIT
57	4150228000	P.C.B HOLDER
59	1130399101	PUSH KNOB (A) ASS'Y
60	1130401303	PUSH KNOB (B) ASS'Y
61	1441042202	FRONT PANEL
62	1430296205	WINDOW
63	1460548208	WINDOW PANEL
64	1441054009	ESC. BAR
65	1130403301	KNOB (C)
66	4630274011	SPRING
67	1460552207	KNOB GUIDE (A)
68	1460553303	KNOB GUIDE (B)

Ref. No.	Part No.	Part Name & Descriptions
69	-	-
70	-	-
71	1310104006	DENON MARK
*72	ETC0557B-4	LAMP UNIT
73	4730304014	TAPPING SCREW (1) 3x8
*74	ETC0556B-5	LED UNIT
*75	ETC0558B-4	POWER LED UNIT
76	4770052009	FIX. SCREW
77	1120408002	KNOB (A)
78	1120409108	KNOB (B)
79	4140278109	SHIELD COVER ASS'Y
80	1020094215	TOP COVER
81	1220064045	SPACER
82	4734801005	TAPPING SCREW (TRUS) 4x8
83	1250004020	SPACER
84	-	-
85	1011377103	WOOD BOARD (R)
86	1011378102	WOOD BOARD (L)
87	-	-
88	1240032015	FELT SHEET
89	4751006016	WASHER φ5 (BLACK)
90	4734461034	TAPPING SCREW (TRUS) 4x25 (BLACK)
91	4752004004	SPRING WASHER φ4
92	4350080006	JOINT
93	4530022208	LAMP COVER (A)
94	4530023207	LAMP COVER (B)
95	1140056007	FLEXIBLE RING
96	4610160006	WASHER
97	WA0107H4	WASHER
98	EP-6214	CORD HOLDER USED 3
99	2020013101	FUSE HOLDER
100	4150088004	INSULATING SHEET
101	2050089008	7P W. TERMINAL
102	4756006008	NUT M3

Ref. No.	Part No.	Part Name & Descriptions
103	4700012022	PAN SCREW WITH W.S.W 3x12
104	2050043109	GND TERMINAL
105	4120871005	RADIATOR BRACKET (A)
106	4120872004	RADIATOR BRACKET (B)
107	4120873003	BRACKET (A)
108	4120874002	BRACKET (B)
109	4770064107	FIXING SCREW
110	4140281002	SHIELD BRACKET
111	4121202000	BRACKET
112	4140277003	SHIELD PLATE (A)
113	4770096007	PUSH RIVET
114	1050548003	BACK PANEL
115	2050043109	GND TERMINAL
116	4770088002	WASHER φ4.1 (NI)
117	4753100004	TOOTH WASHER φ4 (NI)
118	4770006000	NUT M4 (NI)
119	1030399101	PUSH KNOB (A) ASS'Y
120	1130401303	PUSH KNOB (B) ASS'Y
121	1441042202	FRONT PANEL
122	1430296205	WINDOW
123	1460548208	WINDOW PANEL
124	1441054009	ESC. BAR
125	1130403301	KNOB (C)
126	4630274011	SPRING
127	1460552207	KNOB GUIDE (A)
128	1460553303	KNOB GUIDE (B)
129	1310104006	DENON MARK
130	ETC0557B-4	LAMP UNIT
131	4730304014	TAPPING SCREW (1) 3x8
132	ETC0556B-5	LED UNIT
133	ETC0558B-4	POWER LED UNIT
134	4770052009	FIX. SCREW
135	1120408002	KNOB (A)
136	1120409108	KNOB (B)
137	4140278109	SHIELD COVER ASS'Y
138	1020094215	TOP COVER
139	1220064045	SPACER
140	4734801005	TAPPING SCREW (TRUS) 4x8
141	1250004020	SPACER
142	-	-
143	1011377103	WOOD BOARD (R)
144	1011378102	WOOD BOARD (L)
145	-	-
146	1240032015	FELT SHEET
147	4751006016	WASHER φ5 (BLACK)
148	4734461034	TAPPING SCREW (TRUS) 4x25 (BLACK)
149	4752004004	SPRING WASHER φ4
150	4350080006	JOINT
151	4530022208	LAMP COVER (A)
152	4530023207	LAMP COVER (B)
153	1140056007	FLEXIBLE RING
154	4610160006	WASHER
155	WA0107H4	WASHER
156	EP-6214	CORD HOLDER USED 3
157	2020013101	FUSE HOLDER
158	4150088004	INSULATING SHEET
159	2050089008	7P W. TERMINAL
160	4756006008	NUT M3
161	1030399101	PUSH KNOB (A) ASS'Y
162	1130401303	PUSH KNOB (B) ASS'Y
163	1441042202	FRONT PANEL
164	1430296205	WINDOW
165	1460548208	WINDOW PANEL
166	1441054009	ESC. BAR
167	1130403301	KNOB (C)
168	4630274011	SPRING
169	1460552207	KNOB GUIDE (A)
170	1460553303	KNOB GUIDE (B)
171	1310104006	DENON MARK
172	ETC0557B-4	LAMP UNIT
173	4730304014	TAPPING SCREW (1) 3x8
174	ETC0556B-5	LED UNIT
175	ETC0558B-4	POWER LED UNIT
176	4770052009	FIX. SCREW
177	1120408002	KNOB (A)
178	1120409108	KNOB (B)
179	4140278109	SHIELD COVER ASS'Y
180	1020094215	TOP COVER
181	1220064045	SPACER
182	4734801005	TAPPING SCREW (TRUS) 4x8
183	1250004020	SPACER
184	-	-
185	1011377103	WOOD BOARD (R)
186	1011378102	WOOD BOARD (L)
187	-	-
188	1240032015	FELT SHEET
189	4751006016	WASHER φ5 (BLACK)
190	4734461034	TAPPING SCREW (TRUS) 4x25 (BLACK)
191	4752004004	SPRING WASHER φ4
192	4350080006	JOINT
193	4530022208	LAMP COVER (A)
194	4530023207	LAMP COVER (B)
195	1140056007	FLEXIBLE RING
196	4610160006	WASHER
197	WA0107H4	WASHER
198	EP-6214	CORD HOLDER USED 3
199	2020013101	FUSE HOLDER
200	4150088004	INSULATING SHEET
201	2050089008	7P W. TERMINAL
202	4756006008	NUT M3
203	1030399101	PUSH KNOB (A) ASS'Y
204	1130401303	PUSH KNOB (B) ASS'Y
205	1441042202	FRONT PANEL
206	1430296205	WINDOW
207	1460548208	WINDOW PANEL
208	1441054009	ESC. BAR
209	1130403301	KNOB (C)
210	4630274011	SPRING
211	1460552207	KNOB GUIDE (A)
212	1460553303	KNOB GUIDE (B)
213	1310104006	DENON MARK
214	ETC0557B-4	LAMP UNIT
215	4730304014	TAPPING SCREW (1) 3x8
216	ETC0556B-5	LED UNIT
217	ETC0558B-4	POWER LED UNIT
218	4770052009	FIX. SCREW
219	1120408002	KNOB (A)
220	1120409108	KNOB (B)
221	4140278109	SHIELD COVER ASS'Y
222	1020094215	TOP COVER
223	1220064045	SPACER
224	4734801005	TAPPING SCREW (TRUS) 4x8
225	1250004020	SPACER
226	-	-
227	1011377103	WOOD BOARD (R)
228	1011378102	WOOD BOARD (L)
229	-	-
230	1240032015	FELT SHEET
231	4751006016	WASHER φ5 (BLACK)
232	4734461034	TAPPING SCREW (TRUS) 4x25 (BLACK)
233	4752004004	SPRING WASHER φ4
234	4350080006	JOINT
235	4530022208	LAMP COVER (A)
236	4530023207	LAMP COVER (B)
237	1140056007	FLEXIBLE RING
238	4610160006	WASHER
239	WA0107H4	WASHER
240	EP-6214	CORD HOLDER USED 3
241	2020013101	FUSE HOLDER
242	4150088004	INSULATING SHEET
243	2050089008	7P W. TERMINAL
244	4756006008	NUT M3
245	1030399101	PUSH KNOB (A) ASS'Y
246	1130401303	PUSH KNOB (B) ASS'Y
247	1441042202	FRONT PANEL
248	1430296205	WINDOW
249	1460548208	WINDOW PANEL
250	1441054009	ESC. BAR
251	1130403301	KNOB (C)
252	4630274011	SPRING
253	1460552207	KNOB GUIDE (A)
254	1460553303	KNOB GUIDE (B)
255	1310104006	DENON MARK
256	ETC0557B-4	LAMP UNIT
257	4730304014	TAPPING SCREW (1) 3x8
258	ETC0556B-5	LED UNIT
259	ETC0558B-4	POWER LED UNIT
260	4770052009	FIX. SCREW
261	1120408002	KNOB (A)
262	1120409108	KNOB (B)
263	4140278109	SHIELD COVER ASS'Y
264	1020094215	TOP COVER
265	1220064045	SPACER
266	4734801005	TAPPING SCREW (TRUS) 4x8
267	1250004020	SPACER
268	-	-
269	1011377103	WOOD BOARD (R)
270	1011378102	WOOD BOARD (L)
271	-	-
272	1240032015	FELT SHEET
273	4751006016	WASHER φ5 (BLACK)
274	4734461034	TAPPING SCREW (TRUS) 4x25 (BLACK)
275	4752004004	SPRING WASHER φ4
276	4350080006	JOINT
277	4530022208	LAMP COVER (A)
278	4530023207	LAMP COVER (B)
279	1140056007	FLEXIBLE RING
280	4610160006	WASHER
281	WA0107H4	WASHER
282	EP-6214	CORD HOLDER USED 3
283	2020013101	FUSE HOLDER
284	4150088004	INSULATING SHEET
285	2050089008	7P W. TERMINAL
286	4756006008	NUT M3
287	1030399101	PUSH KNOB (A) ASS'Y
288	1130401303	PUSH KNOB (B) ASS'Y
289	1441042202	FRONT PANEL
290	1430296205	WINDOW
291	1460548208	WINDOW PANEL
292	1441054009	ESC. BAR
293	1130403301	KNOB (C)
294	4630274011	SPRING
295	1460552207	KNOB GUIDE (A)
296	1460553303	KNOB GUIDE (B)
297	1310104006	DENON MARK
298	ETC0557B-4	LAMP UNIT
299	4730304014	TAPPING SCREW (1) 3x8
300	ETC0556B-5	LED UNIT
301	ETC0558B-4	POWER LED UNIT
302	4770052009	FIX. SCREW
303	1120408002	KNOB (A)
304	1120409108	KNOB (B)
305	4140278109	SHIELD COVER ASS'Y
306	1020094215	TOP COVER
307	1220064045	SPACER
308	4734801005	TAPPING SCREW (TRUS) 4x8
309	1250004020	SPACER
310	-	-
311	1011377103	WOOD BOARD (R)
312	1011378102	WOOD BOARD (L)
313	-	-
314	1240032015	FELT SHEET
315	4751006016	WASHER φ5 (BLACK)
316	4734461034	TAPPING SCREW (TRUS) 4x25 (BLACK)
317	4752004004	SPRING WASHER φ4
318	4350080006	JOINT
319	4530022208	LAMP COVER (A)
320	4530023207	LAMP COVER (B)
321	1140056007	FLEXIBLE RING
322	4610160006</	

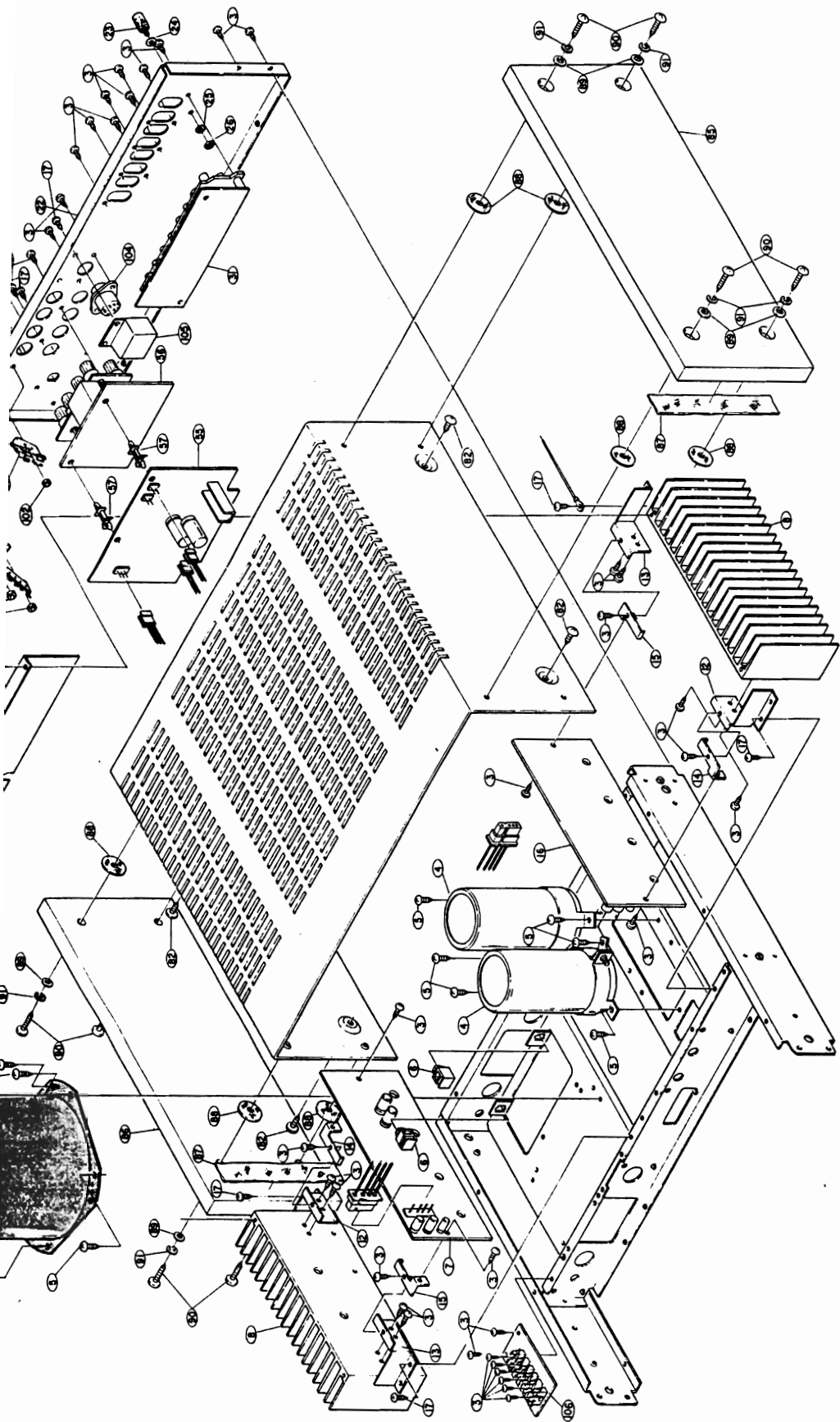

NIPPON COLUMBIA CO., LTD.

No. 14-14, 4-CHOME AKASAKA,
MINATO-KU, TOKYO 107 JAPAN
TEL: 03-584-8111
TLX: JAPANOLA J22591
CABLE: NIPPONCOLUMBIA TOKYO

ADDENDUM LIST

Part Name & Descriptions	Ref. No.	Part No.	Part Name & Descriptions
—	103	4700042005	PAN SCREW 3x8 (BLACK)
DENON MARK	104	2048070003	5P CONNECTOR (DIN)
LAMP UNIT	105	4140310009	SHIELD PLATE
TAPPING SCREW (1) 3x8	106	4121371009	FUSE BRACKET
LED UNIT	107	2061015090	FUSE (5A)
POWER LED UNIT	108	5130654020	FUSE LABEL
FIX. SCREW	109	2412156003	CARBON RESISTOR 470K OHM
KNOB (A)	110	—	NUT M12 (SP) ▲
KNOB (B)	111	—	TOOTHED WASHER φ8 (SP)
SHIELD COVER ASS'Y	112	2050003107	3T LUG
TOP COVER	113	4700026005	TAPPING SCREW WITH WASHER 3x8
SPACER	114	4140215007	SHIELD PLATE
TAPPING SCREW (TRUS) 4x8	115	4150172004	INSULATING SHEET
SPACER	116	4121371009	FUSE BRACKET
—	117	2061015003	FUSE (500mA T)
WOOD BOARD (R)	118	2061015029	FUSE (1A T)
WOOD BOARD (L)	119	2061036011	FUSE (6.3A)
—	120	5130711015	FUSE LABEL (T500mA)
FELT SHEET	121	5130654088	FUSE LABEL (T1A)
WASHER φ5 (BLACK)	122	5130654091	FUSE LABEL (T6.3A)
TAPPING SCREW (TRUS) 4x25 (BLACK)	123	4140310009	SHIELD PLATE
SPRING WASHER φ4	124	2563023006	METALIZED 0.01μF AC 250V
JOINT	125	—	—
LAMP COVER (A)	126	—	—
LAMP COVER (B)	—	—	—
FLEXIBLE RING	—	—	—
WASHER	—	—	—
WASHER	—	—	—
CORD HOLDER USED 3	—	—	—
FUSE HOLDER	—	—	—
INSULATING SHEET	—	—	—
7P W. TERMINAL	—	—	—
NUT M3	—	—	—
PACKING & ACCESSORIES (not included EXPLODED VIEW)			
a.	5040055007	CABINET SHEET	
b.	5030357003	CUSHION	
c.	5010909015	CARTON CASE	
d.	5090014014	SPACER	
e.	5111128009	INST. MANUAL	

Ref. No.	Part Name	Part No.		
		E3 for U.S.A.		E1 for Hong Kong & Singapore
7	POWER (L) UNIT	PUS0021 -1		PUS0021D-1
16	POWER (R) UNIT	PUS0021 -2		PUS0021D-2
22	BACK PANEL	1050551		1050551000
30	EQ. UNIT	ETC0556 -1		ETC0556D-1
31	INPUT UNIT	ETC0556 -2		ETC0556D-2
34	CONTROL UNIT	ETC0557 -1		ETC0557D-1
35	VOLUME UNIT	ETC0557 -2		ETC0557D-2
36	SP. SWITCH UNIT	ETC0557 -3		ETC0557D-3
37	HEAD PHONE UNIT	ETC0556 -3		ETC0556D-3
72	LAMP UNIT	ETC0557 -4		ETC0557D-4
74	LED UNIT	ETC0556 -5		ETC0556D-5
75	POWER LED UNIT	ETC0558 -4		ETC0558D-4
124	METALIZED 0.01μF AC250V			